

EL49730B EL49730W

4" LED Pull Down Insert Kit



PROJECT INFORMATION:

Project Name: _____

Fixture Type: _____

Date: _____

DIMENSIONS

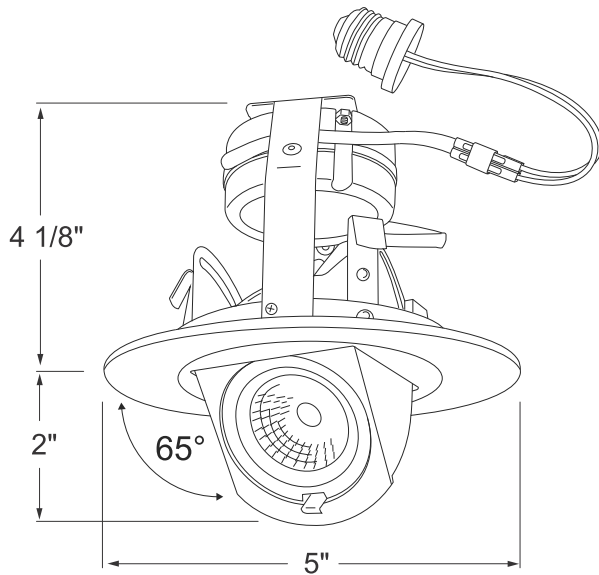

PRODUCT SPECIFICATIONS

- Suitable for use in fixtures installed in insulated ceilings
- Suitable for installation into a 4" recessed fixtures with 2-wire connector.
- Suitable for installation into a 4" recessed fixtures with medium base socket, using PSA30 adaptor (included).
- 65° tilt, 356° rotation
- Housing meets restricted air flow requirement (per ASTM E-283).
- CA Title 24 compliant.
- Meets ENERGY STAR requirements.

Lamp: LED CREE COB chip CRI90

EL49730: 13W, 3000°K, 840 lm, beam angle 36°

LED Driver: 120V AC dimmable

Life-span: 50,000 hours

Labels: UL listed

Warranty: 5 years limited

CATALOG NUMBER

Example: EL49730B (Black)
EL49730W (White)