

EXPF SERIES OUTDOOR LIGHTS

VTA-15-30W-MCTP

HIGH-OUTPUT DUAL-SELECTABLE VAPOR-TIGHT WITH ADJ. ANGLE

MCTP Multi Color Temperature & Multi Power/Wattage (Selectable)

WESTGATE
THE FUTURE IS HERE...AND IT'S QUITE BRIGHT!

Customer Name: _____

Project Name: _____

Note: _____

Type: _____



FIXTURE ADJUSTS A FULL 90°

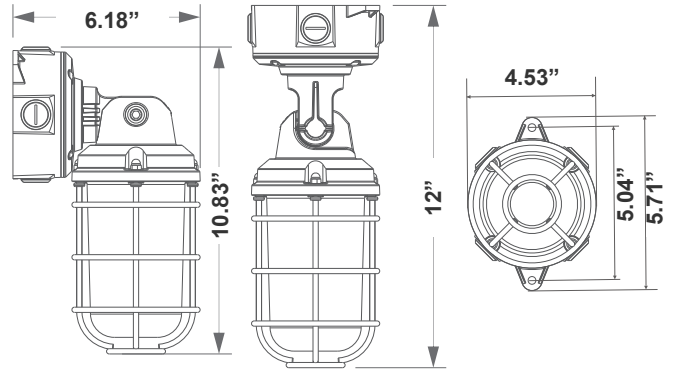

16\"(H) x 6.18\"(W) x 5.71\"(D)

Illuminate your space with precision using our High-Output Dual-Selectable Vapor-Tight Fixture with Adjustable Angle. This versatile lighting solution offers exceptional brightness and flexibility, allowing you to tailor the illumination to your exact needs. With dual-selectable color temperature options and an adjustable angle feature, it's perfect for a wide range of industrial and commercial applications. Experience powerful lighting performance and durability with Westgate Mfg.

Features

- Lens: PC Lens
- Aluminum Alloy Housing
- Aluminum Alloy Housing
- 7-year warranty

Technical Specifications

Electrical:

- Voltage: 120-277V AC 60Hz
- Wattage: 15W/20W/30W
- Power Factor: >0.9
- THD: ≤20%
- Efficacy: 110LM/W

Mechanical:

- 180° Adjustable Arm
- Aluminum Alloy Housing
- Gray Finish
- Operating Temperature: -4°F to 113°F
- IP Rating: IP66, Suitable for Wet Locations
- 7-year Warranty

Lighting:

- Lens: PC Lens
- Total lumens: 3300LM Max.
- Color Temperatures: 3000K/4000K/5000K
- Color Rendering Index: CRI >90
- Beam Angle: 90°-180° Adjustable
- Rated Life: 70,000 Hrs

Applications:

- Industrial Facilities, Food Processing Plants, Outdoor Spaces, Commercial Kitchens, Car Wash Facilities, Cold Storage Facilities, Retail Spaces, Parking Garages.



Phone: (877) 805-2252 | Fax: (877) 805-2252
www.westgatemfg.com |



WG-20240325

Photometrics: VTA-15-30W-MCTP

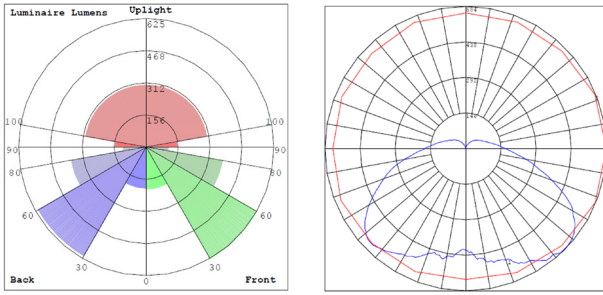

BUG Rating: B1-U3-G2

Other Views:

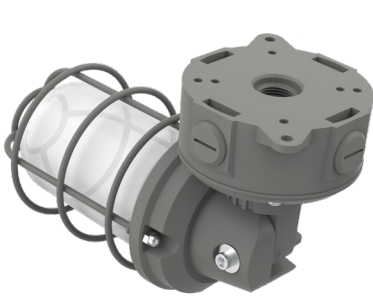

Side View

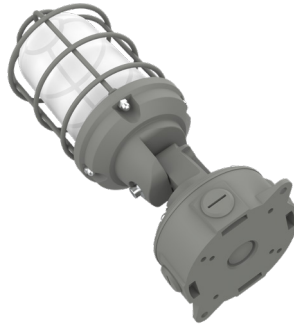

Front View



Back View

Performance Table: VTA-15-30W-MCTP

MODEL NO.	Wattage	Voltage	Lumens	Color Temp.	BUG Rating	LPW
VTA-15-30W-MCTP	15W 20W 30W	120~277V	1650LM 2200LM 3300LM	3000K 4000K 5000K	B1-U3-G2	110

Sample Ordering

Model	Watt	Watt	Color Temp.
VTA	-	15	-
		30W	-
			MCTP

Factory Installed Options:

Blank = No Option For Accessories
 OPT-EM-VTU = INTERNAL EMERGENCY BACKUP BATTERY
 OPT-PC-B = PHOTOCELL
 OPT-CLR-85CBK/GR/SR/WHJ = COLOR PAINTS
 OPT-SEN-3MRLV-5 = PROGRAMMABLE MICROWAVE BI-LEVEL
 WEC-8RC = REMOTE CONTROL

FACTORY INSTALL OPTIONS:



OPT-EM-VTU



OPT-PC-B



OPT-SEN-3MRLV-5



WEC-8RC

