

# RDL SERIES RESIDENTIAL LIGHTING

RDL6-ST-MCT5-BK  
6" Smooth Recessed Trim

Customer Name: \_\_\_\_\_

Project Name: \_\_\_\_\_

Note: \_\_\_\_\_ Type: \_\_\_\_\_

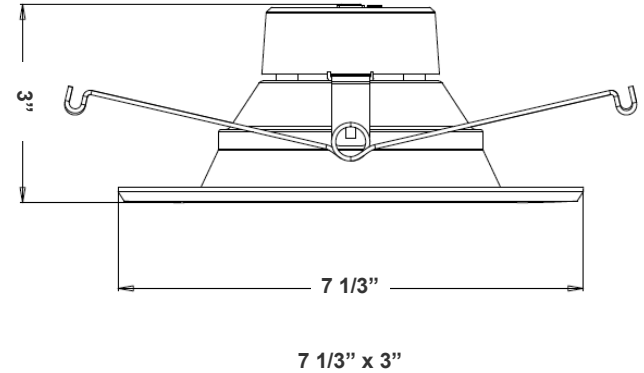
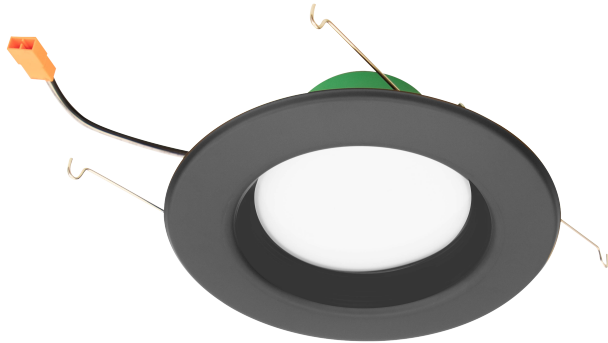

## Features

- 6" Smooth Recessed Trim
- Multi CCT (Selectable Switch on the Back of the driver )
- Isolated Driver for Improved Thermal Management
- 5-Year Warranty
- Spun Aluminum with White Powder Coat Finish

## Technical Specifications

### Electrical:

- Voltage: 120V AC
- Output Voltage: 36VDC
- Power Factor: >0.90
- Wattage: 15W
- Efficacy: 85 LPW
- Total Harmonic Distortion: ≤15 %

### Mechanical:

- Spun Aluminum with White Powder Coat Finish
- Includes 8" Medium Base E-26 Screw-in Adapter That Fits any Standard Incandescent Down-light
- Maximum Ambient Temperature: 104°F
- Fits in Standard 6" Recessed Housings
- Rated life: 50,000 hrs
- Suitable For Wet Location

### Lighting:

- Dimming: TRIAC Dimming (Using Standard TRIAC LED Dimmers)
- LED: Epistar Chip (COB) and Driver—35,000-hour Design Life
- Can Rotate after Installation to Align
- Optics: White Translucent Acrylic Lens
- Total Lumens: 1275LM
- Multi Color Temperatures: 2700K/ 3000K/ 3500K/ 4000K/ 5000K
- Multi CCT (Selectable Switch on the Back of the Driver )
- Color Rendering Index: CRI ≥ 90

### Applications:

- LED retrofit trim have been designed to be a flexible lighting solution for retrofit and new construction applications, Ideal for closets, storage areas, attics, corridors, or general lighting solutions for residential and commercial applications

### Other Models:

- 10W | 700LM | RDL4-ST-MCT5-BK



## Photometrics: RDL6-ST-MCT5-BK

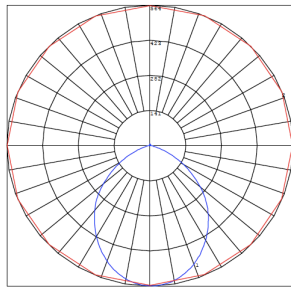
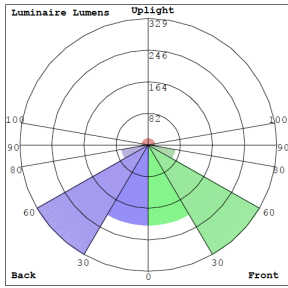

BUG Rating: B1-U2-G0

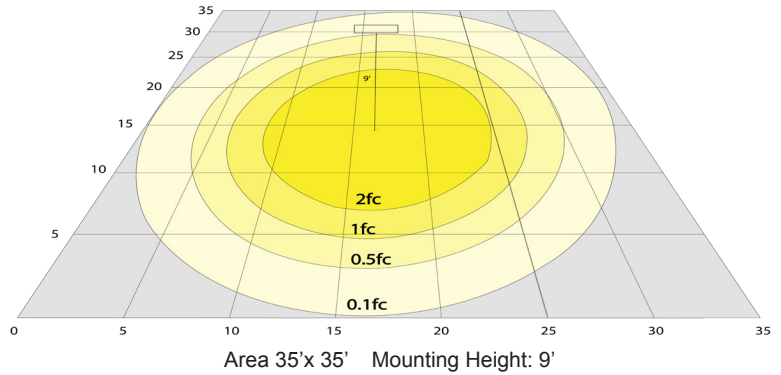

Area 35'x 35' Mounting Height: 9'

## Other Views:



Side View

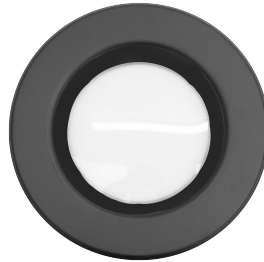

Front View

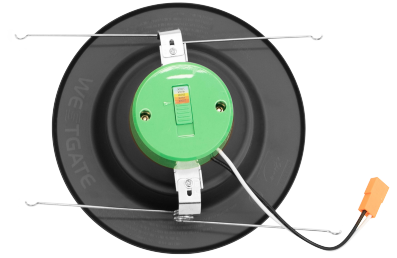

Back View

## Performance Table: RDL6-ST-MCT5-BK

MODEL NO.	Wattage	Voltage	Lumens	Color Temp.	BUG Rating	LPW
RDL6-ST-MCT5-BK	15W	120V	1275LM	2700K/3000K/3500K/4000K/5000K	B1-U2-G0	85

## Sample Ordering

Model	Style	Color Temp.	Housing
RDL6	ST	MCT5	BK

## Accessories:

Blank = No Option For Accessories

- RDL6-BF-TRMB-BK = RDL6-BF SERIES COLOR TRIM, BAFFLE BLACK
- RDL6-BF-TRMB-BN = RDL6-BF SERIES COLOR TRIM, BAFFLE BRUSHED NICKEL
- RDL6-BF-TRMB-ORB = RDL6-BF SERIES COLOR TRIM, BAFFLE OIL-RUBBED BRONZE
- RDL6-BF-TRMB-WH = RDL6-BF SERIES COLOR TRIM, BAFFLE WHITE
- RDL6-BF-TRMS-BK = RDL6-BF SERIES COLOR TRIM, SMOOTH BLACK
- RDL6-BF-TRMS-BN = RDL6-BF SERIES COLOR TRIM, SMOOTH BRUSHED NICKEL
- RDL6-BF-TRMS-ORB = RDL6-BF SERIES COLOR TRIM, SMOOTH OIL-RUBBED BRONZE
- RDL6-BF-TRMS-WH = RDL6-BF SERIES COLOR TRIM, SMOOTH WHITE
- E26-CONVERTER = SCREW-IN ADAPTER THAT FITS ANY STANDARD

## Factory-installed Option:

Blank = No Option For Accessories  
OPT-EM-DL1EXT = EXTERNAL BATTERY BACKUP

## ACCESSORY:



## FACTORY-INSTALLED OPTION:



OPT-EM-DL1EXT  
EXTERNAL BATTERY BACKUP

## Example:

- RDL6-ST-MCT5-BK (FOR RDL6 15W MCT5 FIXTURE 120V)
- RDL6-ST-MCT5-BK (FOR RDL6 15W MCT5 FIXTURE 120V)  
OPT-EM-DL1EXT (EXTERNAL BATTERY BACKUP)



## Compatible Dimmer List:

MODEL NO.	BRAND	MODEL NO.	BRAND
LUXDM600-12 600W	ALMOND	S-600-IV 600W	LUTRON
SDM3/1000/WHTTE 1000W	AH	S-600-AL 600W	LUTRON
SDM/600/WHTTE 600W	AH	D-600R-IV 600W	LUTRON
18024 600W	GE	DV-603PH-WH 600W	LUTRON
6683 600W	LEVITON	S-603PH-WH 600W	LUTRON
6631-LA 600W	LEVITON	AY-600P-WH	LUTRON
LIGHT ALMOND NO.6672 600W	LEVITON	AYCL-153PH	LUTRON
603-6631-A 600W	LEVITON	SELV-300P-WH	LUTRON
6631-A 600W	LEVITON	DV-600P-WH	LUTRON
White/Lvory/Light Almond IPI10-1LZ 600W	LEVITON	SCL-153PH-WH	LUTRON
DV-603P600W	LUTRON	MACL-153MH-WH	LUTRON
S-600 600W	LUTRON	DVCL-253PH	LUTRON
DV-603PH-WH 600W	LUTRON	MSCL-OP153MH-WH	LUTRON
DV-600PH-WH 600W	LUTRON	MACL-153MLH-WH	LUTRON
S-603PGH-WH 600W	LUTRON	6683 600W	LEVITON
S-10PH 1000W	LUTRON	6631-LA 600W	LEVITON
D-600RH-DK 600W	LUTRON	LIGHT ALMOND NO.6672 600W	LEVITON
TG-600PH-WH 600W	LUTRON	603-6631-A 600W	LEVITON
SCL-153P-WH 600W	LUTRON	6631-A 600W	LEVITON
D-600R-WH 600W	LUTRON	White/Lvory/Light Almond IPI10-1LZ 600W	LEVITON

