

COB SERIES TAPE LIGHT

24V DC High Output COB seamless tape light

COB Tape Light features uniform illumination without the need for additional diffused covers or accessories. Featuring a premium seamless line of light making it an ideal solution for areas with low clearance or reflective surfaces to eliminate virtually all dotting or spot-glare effects.

- Seamless COB design that eliminates virtually all LED dotting
- Available in 2700K, 3000K, 3500K, 4000K, and 5000K
- 90+ color rendering index
- Lumen output ranging from 349Lm to 448Lm per foot
- Cuttable every 1.97" with 16.4ft max run
- Easy installation featuring 3M VHB adhesive backing
- Available in IP20 uncoated, IP54 coated, and IP65 Jacketed
- Dimmable (5-100%) with most ELV, TRIAC dimmers
- cULus Listed for indoor dry (IP20) or wet (IP65) locations
- JA8 Compliant
- 50,000 hours rated life
- Suitable for use in closets when used in an enclosed mounting channel and installed in accordance with NFPA 70, NEC section 410.16 (B)(3) and 410.16 (D)(1)(Exception)



PROJECT: _____

TYPE: _____

LOCATION: _____

CATALOG NUMBER: _____

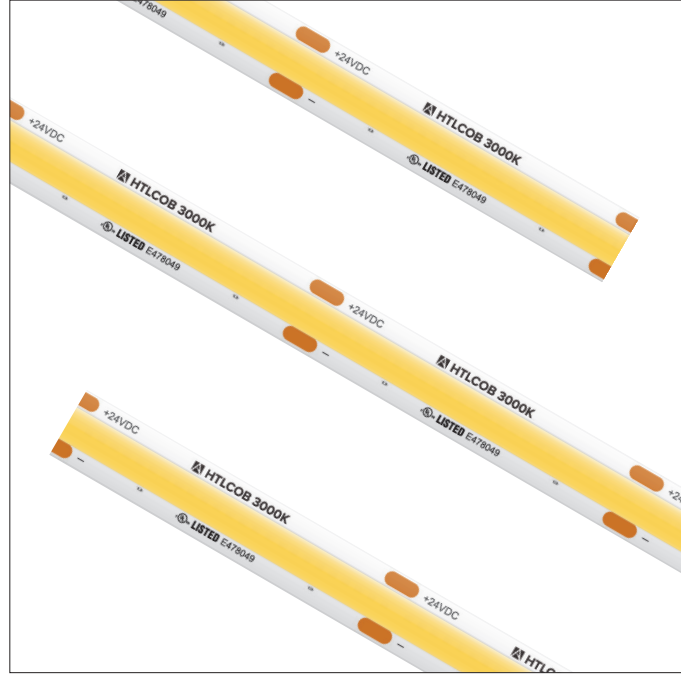

COB SERIES QUICK SPECS

VOLTAGE	24V DC
WATTAGE	4.5W / ft
LUMENS	Up to 448Lm / ft
CCT OPTIONS	2700K / 3000K / 3500K / 4000K / 5000K
CRI	90+
MAX RUN	16.4ft
CUTTING POINTS	1.97" (50mm)
IP RATING	IP20 - Uncoated / IP65 - Jacketed
DIMMING	TRIAC / ELV (5-100%)
DIMENSIONS	0.39" (10mm) W x 0.09" (2.5mm) H
BEAM ANGLE	120°
OPERATING TEMP	5°C (41°F) to 70°C (158°F)
CERTIFICATIONS	cULus Listed - Dry Locations (IP20) & Wet Locations (IP65)
RATED LIFE	50,000 Hours

COB SERIES IP RATINGS

IP20 (Uncoated)
Uncoated tape light and LED's
Best suited: Indoor dry location

IP54 (Coated)
Features a light nano-coating applied to the tape light and LED's that protects from moisture and dust.
Best suited: Indoor dry & damp locations

IP65 (Jacketed)
Features a clear protective silicone jacketing that protects the tape light from sprayed water and dust.
Best suited: Indoor & Outdoor damp & wet locations

COB SERIES QUICK LOOK

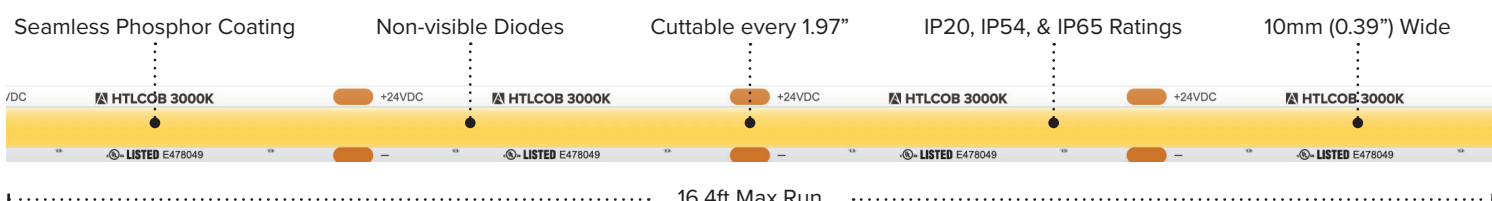

COB SERIES ORDERING INFORMATION

ITEM NUMBER	VOLTAGE	CCT	LENGTH	LUMENS / FT	WATTAGE / FT	IP RATING	CRI	CUTTING	MAX RUN
HTL20-COB-UWW-16	24V DC	2700K	16.4 ft	369Lm / ft	4.5W / ft	IP20	90+	1.97"	16.4 ft
HTL-COB-UWW-16	24V DC	2700K	16.4 ft	369Lm / ft	4.5W / ft	IP54	90+	1.97"	16.4 ft
HTL65-COB-UWW-16	24V DC	2700K	16.4 ft	349Lm / ft	4.5W / ft	IP65	90+	1.97"	16.4 ft
HTL-COB-UWW-100	24V DC	2700K	100 ft	369Lm / ft	4.5W / ft	IP54	90+	1.97"	16.4 ft
HTL20-COB-WW-16	24V DC	3000K	16.4 ft	409Lm / ft	4.5W / ft	IP20	90+	1.97"	16.4 ft
HTL-COB-WW-16	24V DC	3000K	16.4 ft	409Lm / ft	4.5W / ft	IP54	90+	1.97"	16.4 ft
HTL65-COB-WW-16	24V DC	3000K	16.4 ft	379Lm / ft	4.5W / ft	IP65	90+	1.97"	16.4 ft
HTL-COB-WW-100	24V DC	3000K	100 ft	409Lm / ft	4.5W / ft	IP54	90+	1.97"	16.4 ft
HTL20-COB-NW-16	24V DC	3500K	16.4 ft	413Lm / ft	4.5W / ft	IP20	90+	1.97"	16.4 ft
HTL-COB-NW-16	24V DC	3500K	16.4 ft	413Lm / ft	4.5W / ft	IP54	90+	1.97"	16.4 ft
HTL65-COB-NW-16	24V DC	3500K	16.4 ft	387Lm / ft	4.5W / ft	IP65	90+	1.97"	16.4 ft
HTL-COB-NW-100	24V DC	3500K	100 ft	413Lm / ft	4.5W / ft	IP54	90+	1.97"	16.4 ft
HTL20-COB-WH-16	24V DC	4000K	16.4 ft	460Lm / ft	4.5W / ft	IP20	90+	1.97"	16.4 ft
HTL-COB-WH-16	24V DC	4000K	16.4 ft	460Lm / ft	4.5W / ft	IP54	90+	1.97"	16.4 ft
HTL65-COB-WH-16	24V DC	4000K	16.4 ft	415Lm / ft	4.5W / ft	IP65	90+	1.97"	16.4 ft
HTL-COB-WH-100	24V DC	4000K	100 ft	460Lm / ft	4.5W / ft	IP54	90+	1.97"	16.4 ft
HTL20-COB-CW-16	24V DC	5000K	16.4 ft	448Lm / ft	4.5W / ft	IP20	90+	1.97"	16.4 ft
HTL-COB-CW-16	24V DC	5000K	16.4 ft	448Lm / ft	4.5W / ft	IP54	90+	1.97"	16.4 ft
HTL65-COB-CW-16	24V DC	5000K	16.4 ft	434Lm / ft	4.5W / ft	IP65	90+	1.97"	16.4 ft
HTL-COB-CW-100	24V DC	5000K	100 ft	448Lm / ft	4.5W / ft	IP54	90+	1.97"	16.4 ft

16.4ft Reels (IP20/IP54) Include: 6ft lead, 6ft tail, (1) TL-CONKIT, (2) TL-BLKS, (2) TL-2PWR-HD
 16.4ft Reels (IP65) Include: 2ft Lead +6" Conkit, 2ft Tail +6" Conkit, (2) TL-2PWR-HD
 100ft Reels (IP54) Include: 6ft lead, 6ft tail, (1) TL-CONKIT, (3) TL-BLKS, (3) TL-2PWR-HD

COB SERIES ACCESSORIES

ITEM NUMBER	DESCRIPTION
TL-CONKIT	6' Trulink 4-in-1 Connection Kit
TL-BLKS	Trulink 4-in-1 Connector Block (QTY 10)
TL-2PWR-HD	6' HD Power Feed (IP54)
TL-2JUMP6-HD	6" HD Linking Cable (IP54)
TL-2JUMP24-HD	24" HD Linking Cable (IP54)
TL-2SPL-HD	HD Tape to Tape Splice Connector (IP54)
TL-2SPL-L-HD	90° "L" HD Tape to Tape Splice Connector (IP54)
TL-2JUMP65-.5	6" Linking Cable (IP65)
TL-2JUMP65-1	12" Linking Cable (IP65)
TL-2JUMP65-2	24" Linking Cable (IP65)
WIRE-15-2PIN	15ft (20/2) Wire Spool
WIRE-CMP-100-3PIN	100ft (16/3) In-wall Rated Wire Spool
INLINE-SC-CTRL	Simple Select In-line Controller (Single Color)
LVSB-2PIN	In-Line Splice Terminal Block
RCWY-PVC-1M	1m Plastic Wire Cover Raceway (White)



RECOMMENDED POWER SUPPLIES

ITEM NUMBER	DESCRIPTION	MAX / MIN LOAD	INPUT VOLTAGE	OUTPUT VOLTAGE	DIMMABLE	DIMENSIONS
ADPT-DRJ-30-24	Adaptive Series 30W	30W / 3W	100-277V AC	24V	Yes*	6.49"L x 3.6"W x 1.02"H
ADPT-DRJ-60-24	Adaptive Series 60W	60W / 6W	100-277V AC	24V	Yes*	7.4"L x 3.6"W x 1.02"H
ADPT-DRJ-96-24	Adaptive Series 96W	96W / 9.6W	100-277V AC	24V	Yes*	8.66"L x 3.6"W x 1.61"H
ADPT-DRJ-192-24	Adaptive Series 192W (2 x 96W)	192W / 19.2W	100-277V AC	24V	Yes*	10.94"L x 4.25"W x 1.8"H
ADPT-DRJ-288-24	Adaptive Series 288W (3 x 96W)	288W / 28.8W	100-277V AC	24V	Yes*	11.85"L x 4.25"W x 1.8"H

Phase Dimming Compatible With Most MLV, ELV, and TRIAC Dimmers

COB SERIES CUT INCREMENT GUIDE

Segment	Length (MM)	Length (Inches)	Length (Feet)
1	50	1.97	0.16
2	100	3.94	0.33
3	150	5.91	0.49
4	200	7.87	0.66
5	250	9.84	0.82
6	300	11.81	0.98
7	350	13.78	1.15
8	400	15.75	1.31
9	450	17.72	1.48
10	500	19.68	1.64
11	550	21.65	1.80
12	600	23.62	1.97
13	650	25.59	2.13
14	700	27.56	2.30
15	750	29.53	2.46
16	800	31.5	2.63
17	850	33.46	2.79
18	900	35.43	2.95
19	950	37.4	3.12
20	1000	39.37	3.28
21	1050	41.34	3.45
22	1100	43.31	3.61
23	1150	45.28	3.77
24	1200	47.24	3.94
25	1250	49.21	4.10
26	1300	51.18	4.27
27	1350	53.15	4.43
28	1400	55.12	4.59
29	1450	57.09	4.76
30	1500	59.06	4.92
31	1550	61.02	5.09
32	1600	62.99	5.25
33	1650	64.96	5.41
34	1700	66.93	5.58

Segment	Length (MM)	Length (Inches)	Length (Feet)
35	1750	68.9	5.74
36	1800	70.87	5.91
37	1850	72.83	6.07
38	1900	74.8	6.23
39	1950	76.77	6.40
40	2000	78.74	6.56
41	2050	80.71	6.73
42	2100	82.68	6.89
43	2150	84.65	7.05
44	2200	86.61	7.22
45	2250	88.58	7.38
46	2300	90.55	7.55
47	2350	92.52	7.71
48	2400	94.49	7.87
49	2450	96.46	8.04
50	2500	98.43	8.20
51	2550	100.39	8.37
52	2600	102.36	8.53
53	2650	104.33	8.69
54	2700	106.3	8.86
55	2750	108.27	9.02
56	2800	110.24	9.19
57	2850	112.2	9.35
58	2900	114.17	9.51
59	2950	116.14	9.68
60	3000	118.11	9.84
61	3050	120.08	10.01
62	3100	122.05	10.17
63	3150	124.02	10.34
64	3200	125.98	10.50
65	3250	127.95	10.66
66	3300	129.92	10.83

Segment	Length (MM)	Length (Inches)	Length (Feet)
67	3350	131.89	10.99
68	3400	133.86	11.16
69	3450	135.83	11.32
70	3500	137.79	11.48
71	3550	139.76	11.65
72	3600	141.73	11.81
73	3650	143.7	11.98
74	3700	145.67	12.14
75	3750	147.64	12.30
76	3800	149.61	12.47
77	3850	151.57	12.63
78	3900	153.54	12.80
79	3950	155.51	12.96
80	4000	157.48	13.12
81	4050	159.45	13.29
82	4100	161.42	13.45
83	4150	163.39	13.62
84	4200	165.35	13.78
85	4250	167.32	13.94
86	4300	169.29	14.11
87	4350	171.26	14.27
88	4400	173.23	14.44
89	4450	175.2	14.60
90	4500	177.17	14.76
91	4550	179.13	14.93
92	4600	181.1	15.09
93	4650	183.07	15.26
94	4700	185.04	15.42
95	4750	187.01	15.58
96	4800	188.98	15.75
97	4850	190.94	15.91
98	4900	192.91	16.08
99	4950	194.88	16.24
100	5000	196.85	16.40

COMPATIBLE MOUNTING CHANNELS 10mm



ECONOMY

EE1-AAFR

Dimensions: 5/8" (16mm) W
x 1/4" (7mm) H

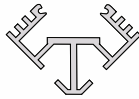

ECONOMY 45

EE45-AAFR

Dimensions: 3/4" (19mm) W
x 3/4" (19mm) H

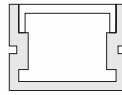

UNIVERSAL

PE-AA2 / PE-UNV

Dimensions: 16/25" (16mm) W
x 47/100" (12mm) H



UNIVERSAL MINI

PE-AA1 / PE-UNV MINI

Dimensions: 19/32" (15mm) W
x 1/4" (6mm) H

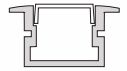

DOUBLE FLANGE

PE-AA2DF

Dimensions: 5/8" (16mm) W
x 7/16" (11mm) H



MINI DOUBLE FLANGE

PE-AA1DF

Dimensions: 19/32" (15mm) W
x 5/32" (4mm) H

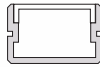

GT

PE-GT

Dimensions: 3/4" (19mm) W
x 1/2" (12mm) H

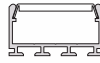

GTX

PE-GTX

Dimensions: 1" (26mm) W
x 9/16" (14.5mm) H

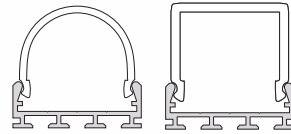

TURBO

PE-TURBO2

Dimensions: 1" (26mm) W x 1" (25mm) H

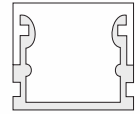

TRACE

PE-TRACE

Dimensions: 13/16" (21mm) W
x 13/16" (21mm) H

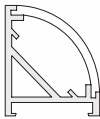

RADIUS

PE-RAD

Dimensions: 25/32" (20mm) W
x 29/32" (23mm) H

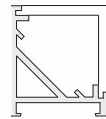

RUBIK

PE-RUBIK

Dimensions: 29/32" (23mm) W
x 25/32" (20mm) H



STANT

PE-SSTANT

Dimensions: 1-3/16" (30mm) W
x 1/4" (7mm) H



TRIPLE STANT

PE-3STANT

Dimensions: 2-11/32" (59mm) W
x 3/8" (9mm) H



DYAD

PE-DYAD

Dimensions: 1.35" (34.2mm) W
x 0.47" (12mm) H



CAMBER

PE-CMBR

Dimensions: 0.71" (18mm) W x
0.23" (5.7mm) H

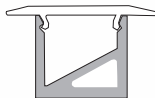

BEVEL 28

PE-B28

Dimensions: .47" (12mm) W
x .47" (12mm) H

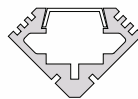

PREMIUM 45

PE-AA45

Dimensions: 3/4" (19mm) W
x 3/4" (19mm) H



PRO 45

PE-PRO45

Dimensions: 1-3/16" (30mm) W
x 7/16" (10mm) H

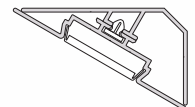

PRO 30

PE-PRO30

Dimensions: 1-13/16" (46mm) W
x 1-1/16" (27mm) H

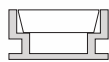

HELM

PE-HELM

Dimensions: 13/16" (20mm) W
x 11/32" (8.5mm) H

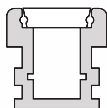

PAVER

PE-PAVER

Dimensions: 1" (26mm) W
x 1" (26mm) H

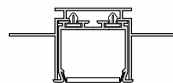

MINI FLANGE SLOT

PE-SLOT

Dimensions: 1-3/16" (30mm) W
x 15/16" (24mm) H

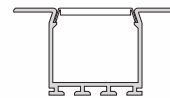

STANDARD FLANGE SLOT

PE-DFSLOT

Dimensions: 1" (25mm) W
x 15/16" (24mm) H

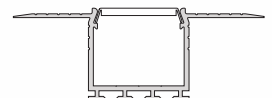

INVISIBLE SLOT

PE-INVSLT

Dimensions: 1-1/16" (27mm) W
x 15/16" (24mm) H



VERGE

PE-VERGE

Dimensions: 4.85" (123.83mm) W
x 25/64" (10mm) H

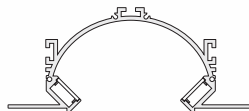

ARC

PE-ARC

Dimensions: 4-13/16" (122.4mm) W
x 2" (50.8mm) H



SCOOP WW

PE-SWW

Dimensions: .54" (13.59mm) W
x 3.79" (96mm) H

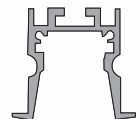

REGAL REGRESS

PE-REG

Dimensions: 1.16" (29.49mm) W
x 1.03" (26.25mm) H



STRUT:

PE-STRUT

Dimensions: 5/8" (15.5mm) W
x 1-3/8" (29.89mm) H

NOTES ON CLOSET LIGHTING

Closet Lighting | NEC 410.16 | Brief Overview

Please see 2026 NFPA NEC Code Book Section 41.16 for details code requirements

Do Closets Need Lighting?

- Not required by the NEC Code
- If installed, lighting must comply with NEC 410.1

Why Closet Lighting Is Regulated

- Clothing, fabric, and paper materials can be combustible
- Tight spaces increase fire risk
- Rules protect people and property
-

Approved Fixture Types

- Surface-mounted or recessed LED or incandescent
- Light source must be fully enclosed
- Fluorescent fixtures allowed
- Fixtures labeled for closet use are preferred
- Open or partially exposed bulbs are not allowed including pendants

What Counts as “Storage Space”?

- From floor to 6ft high or highest hanging rod
 - 24in out from side and back walls
 - Above shelves, up to ceiling within 12in of wall or shelf depth
 - 12in on each side of double-sided hanging rods
- Fixtures must stay outside this space unless specifically rated.

Minimum Clearance Requirements

From storage space:

- 12 in → Surface-mounted enclosed LED/incandescent
- 6 in → Recessed enclosed LED/incandescent

Benefits of Surface-Mounted vs. Recessed

Surface-Mounted

- Easy install
- Ideal for shallow closets
- Flexible placement

Recessed

- Clean, modern look
- No protrusions
- Requires wall/ceiling depth

Wiring & Controls

- Wiring must meet NEC standards
- Conductors must be protected
- Light switch should be near the entrance

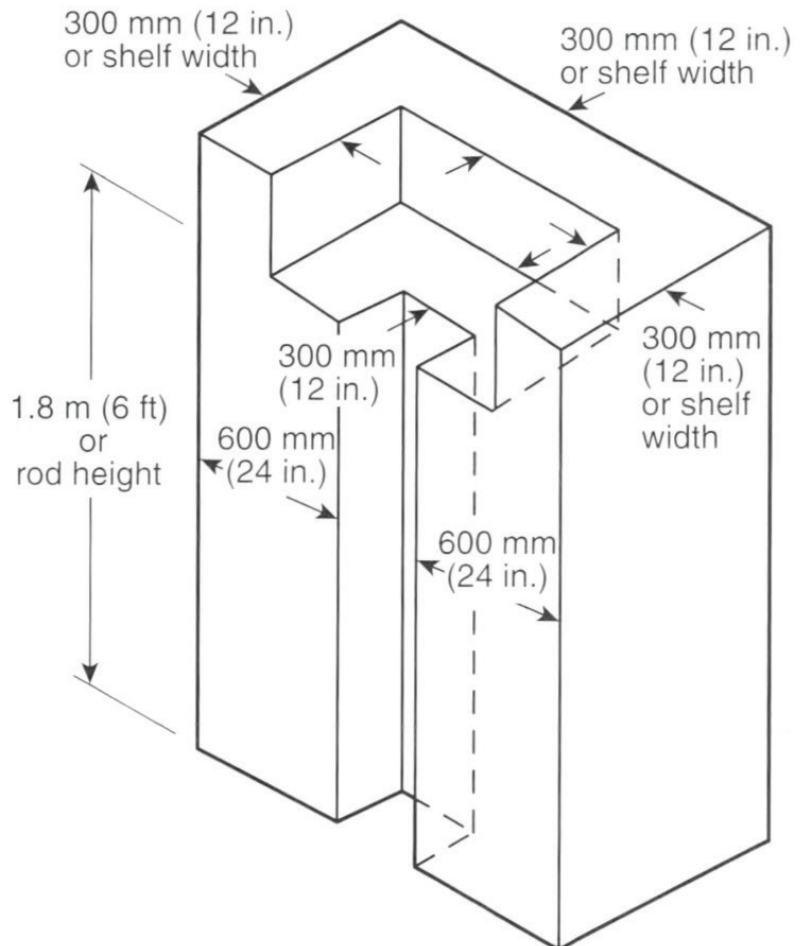
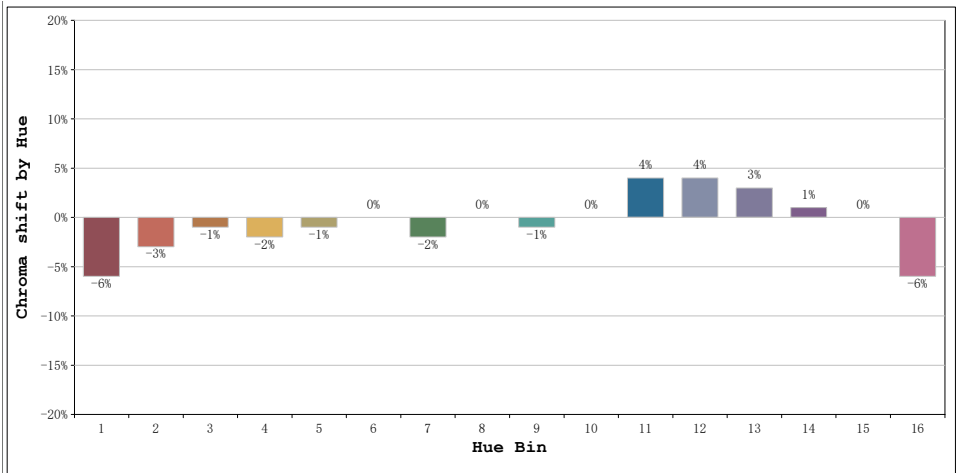
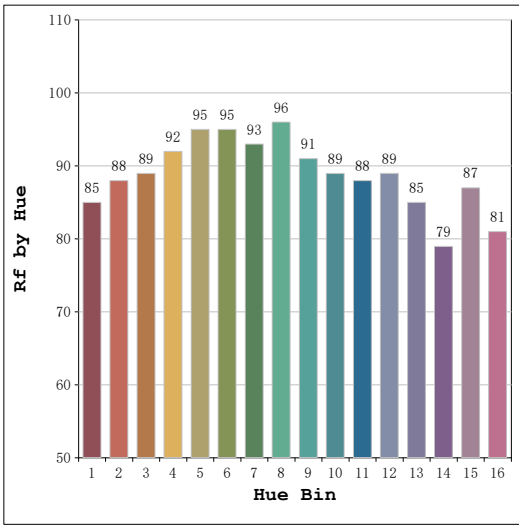
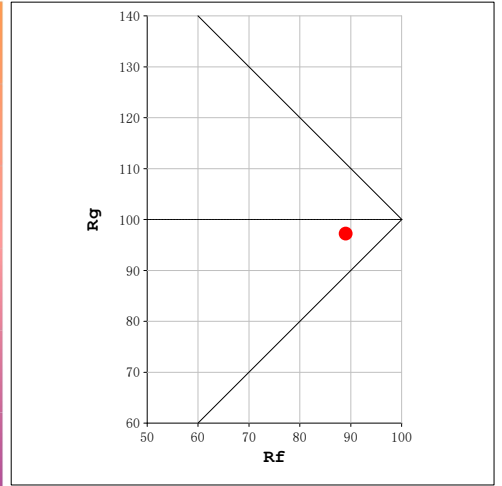
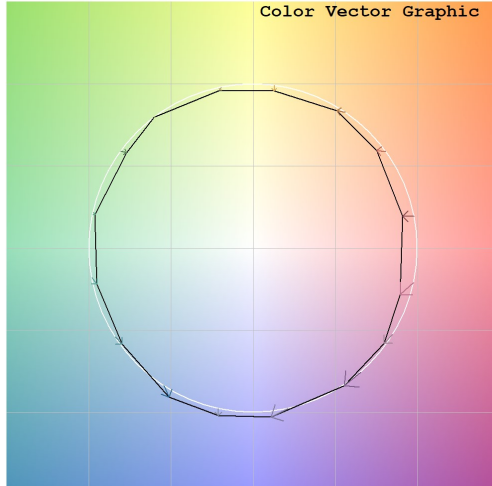
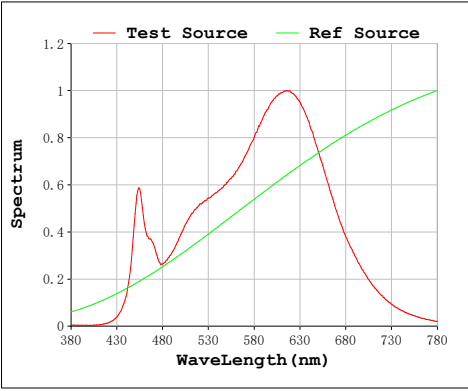

FIGURE 410.16(A) Clothes Closet Storage Space.

HTL-COB SERIES TM-30 DATA - 3000K

Rf: 89 CCT: 3033 K u': 0.2496
 Rg: 97 Duv: -0.0004 v': 0.5202



Hue Bin	Hue Angle	Rf	Graphic shift(%)	
			Chroma	Hue
1	0.0° - 22.5°	85	-6	1
2	22.5° - 45.0°	88	-3	4
3	45.0° - 67.5°	89	-1	5
4	67.5° - 90.0°	92	-2	0
5	90.0° - 112.5°	95	-1	1
6	112.5° - 135.0°	95	0	1
7	135.0° - 157.5°	93	-2	0
8	157.5° - 180.0°	96	0	2
9	180.0° - 202.5°	91	-1	4
10	202.5° - 225.0°	89	0	6
11	225.0° - 247.5°	88	4	6
12	247.5° - 270.0°	89	4	1
13	270.0° - 292.5°	85	3	-10
14	292.5° - 315.0°	79	1	-12
15	315.0° - 337.5°	87	0	-6
16	337.5° - 360.0°	81	-6	-8



AMERICAN LIGHTING WARRANTY

LIMITED WARRANTY FOR LED PRODUCTS: 5 YEARS

AVERAGE LIFE

Average incandescent lamp life, rated life and average life are terms used to describe the number of hours at which half of the lamps have failed. For LEDs, the hours of rated life specify the point at which 70% of original lumen output is reached. Below this point, the effective life is over, however, the LED may still emit light. Individual results may vary with actual environmental conditions including, but not limited to, proper installation, ambient temperature and/or input voltage fluctuations.

Warranty life based on average 8 hours/day use, 7 days/week. Product should be cycled off for at least 6 hours per day.

SAFETY

You must disconnect lighting products from the power supply before servicing or replacing bulbs. Only qualified personnel should install and perform service on lighting products. Periodic inspection and maintenance is required to keep equipment operating properly and at peak performance. Do not mount fixtures on or adjacent to combustible materials.

Lighting products may present a possible shock or fire hazard if improperly installed or attached in any way. Products should always be installed in accordance with their instruction manuals, current electrical codes, and/or the current National Electric Code (NEC). Code compliance is the sole responsibility of the person, company, or party performing the installation of product. Failure to comply with national and/or regional safety codes may result in hazardous or dangerous conditions, damage to property or life, and/or altered product performance/specifications.

LIMITED PRODUCT WARRANTY

Our products are warranted to be free from defects in material and workmanship for the warranty period listed on the reverse by product category. Warranty periods begin from the date of shipment from American Lighting Inc's warehouse to the original purchaser. Products that prove to be defective during their specific warranty period will be either repaired or replaced, at the sole discretion of American Lighting Inc. Claims for defective products must be submitted in writing to American Lighting Inc's RGA Department within the warranty period. Upon approval of such return, American Lighting Inc reserves the right to inspect the product for misuse or abuse. Claims for indirect or consequential damages or for any product that, in American Lighting Inc's opinion, has been misused will be denied. This is a warranty of product reliability only and not a warranty of merchantability or fitness for a particular purpose. American Lighting Inc shall have no liability whatsoever in any event for payment of incidental or consequential damages, including, without limitations, installation costs and/or damages for personal injury and/or property. These products may represent a possible shock or fire hazard if improperly installed or altered in any way. This warranty does not apply to any product that has not been properly installed in accordance with current local codes and/or the National Electrical Code. Products that require a transformer, driver or power supply must be used in conjunction with American Lighting Inc's recommended power supply to ensure safety and retain product warranty. Limited Product Warranty applies to lengths up to 75 feet for rope light products.

STANDARD LINEAR WARRANTY

Rope light and linear lighting products in all their various types and shapes, whether LED or incandescent, are wired in series parallel. This means that several individual lamps or LEDs are wired together in series to equal 12V, 24V or 120V. Then these sections are wired together (in parallel) to light up in unison. If one solder joint, lamp or resistor fails, a whole section will not light. Due to the number of elements involved, and the numerous extenuating circumstances beyond our control, American Lighting Inc offers a [Standard Linear Warranty](#) on most linear lighting products. The limited liability warranty is listed above, however the Standard Linear Warranty offers replacement product by section due to defective material and/or workmanship for one year beginning from the date of shipment from American Lighting Inc's warehouse to the original purchaser.

USE OF LINEAR LIGHTING IN OUTDOOR APPLICATIONS

Incandescent rope light and LED Flexbrite UL 2388 custom cuts; incandescent and LED Flexbrite pre-packaged kits; and UL Listed (special order) cuts of LED Neon Flexbrite Plus and Economy have factory assembled power connections and end caps that seal the rope from moisture. Due to strict quality control standards, American Lighting is able to offer a limited warranty on these items rather than the standard linear lighting warranty that replaces product by defective section only. For outdoor applications, best practices include using kits interconnected (same length kits are best for color control of White LED Flexbrite) or using custom cuts that do not exceed 75 feet.

For all linear lighting categories, any non-rated field connection made in an outdoor application should be properly sealed with dielectric grease covering all conductive materials; and properly installed power connections and end caps, sealed with dielectric grease, silicone, and heat shrink tube. However, since non-rated (field executed) power connections of linear lighting products cannot be quality controlled, and outdoor use of non-rated product is not recommended, American Lighting cannot warrant the product to any purchaser.

PRODUCT SPECIFICATIONS

For the latest product information, updates, instructions and details concerning specifications, colors, finishes, performance, installation and design, visit www.americanlighting.com. Color may vary from the color printed herein due to limitations in photographic and printing processes. American Lighting Inc. reserves the right to change product specifications without notice. Other product specifications such as color temperature, wavelength characteristics and lumen output are subject to production limitations and may vary.

LED technology is changing rapidly, and not all color temperatures and performance levels can be duplicated at a later time. Best practices include purchasing 10-15% additional product for a project on the same initial order where white LED color temperatures must be maintained over project and product life. Eventual product replacement should be considered at layout and design stages. Best practices also include testing connections and product performance prior to mounting and/or installing.