

HTL SERIES TAPE LIGHT

24V DC High Output Single Color

Our most popular tape light option, the High Output series is a go to for most applications in part to the great lumen output with a slightly longer max run. With up to 310 lumens a foot and a max run up to 22 feet, High Output tape light provides a perfect blend of lumens, light quality, and color temperature options for multiple applications.

- Available in 2700K, 3000K, and 4000K
- Up to 96+ color rendering index
- Lumen output ranging from 200Lm to 310Lm per foot
- Cuttable every 3.94" with 22ft max run
- Easy installation featuring 3M VHB adhesive backing
- Available in IP54 & IP65 rating options
- Dimmable (5-100%) with most ELV, TRIAC dimmers
- cULus Listed for indoor dry/damp, and wet locations
- JA8 Compliant
- 50,000 hours rated life
- Suitable for use in closets when used in an enclosed mounting channel and installed in accordance with NFPA 70, NEC section 410.16 (B)(3) and 410.16 (D)(1)(Exception)



PROJECT: _____

TYPE: _____

LOCATION: _____

CATALOG NUMBER: _____



SPTL SERIES QUICK SPECS	
VOLTAGE	24V DC
WATTAGE	4.5W / ft
LUMENS	Up to 310Lm / ft
CCT OPTIONS	2700K / 3000K / 4000K
CRI	96+
MAX RUN	22ft
CUTTING POINTS	3.94" (100mm)
IP RATING	IP54 - Coated / IP65 - Jacketed
DIMMING	TRIAC / ELV (5 - 100%)
DIMENSIONS	0.39" (10mm) W x 0.06" (1.65mm) H
BEAM ANGLE	120°
OPERATING TEMP	5°C (41°F) to 70°C (158°F)
CERTIFICATIONS	cULus Listed - Dry / Damp Location / JA8 Compliant
RATED LIFE	50,000 Hours

HTL SERIES IP RATINGS

- IP54 (Coated)**
 Features a light nano-coating applied to the tape light and LED's that protects from moisture and dust.
Best suited: Indoor dry & damp locations
- IP65 (Jacketed)***
 Features a clear protective silicone jacketing that protects the tape light from sprayed water and dust.
Best suited: Indoor & Outdoor damp & wet locations

*Not suitable for exposure to chemicals or salt.

HTL SERIES QUICK LOOK

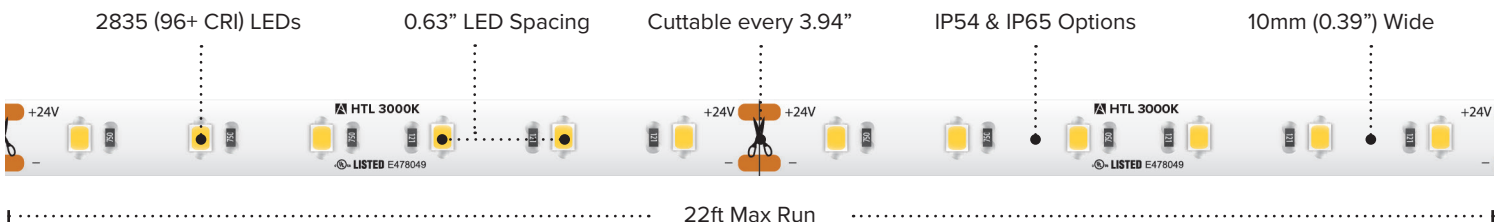

HTL SERIES ORDERING INFORMATION *Custom Cut Orders - Please Allow Up To 2-4 Weeks Order Processing & Delivery*

ITEM NUMBER	VOLTAGE	CCT	LENGTH	LUMENS / FT	WATTAGE / FT	IP RATING	CRI	CUTTING	MAX RUN
HTL-UWW	24V DC	2700K	16.4 ft	285Lm / ft	4.6W / ft	IP54	96+	3.94" (100mm)	22 ft
HTL65-UWW	24V DC	2700K	16.4 ft	260Lm / ft	4.6W / ft	IP65	96+	3.94" (100mm)	22 ft
HTL-UWW-100	24V DC	2700K	100 ft	285Lm / ft	4.6W / ft	IP54	96+	3.94" (100mm)	22 ft
HTL-WW	24V DC	3000K	16.4 ft	300Lm / ft	4.6W / ft	IP54	96+	3.94" (100mm)	22 ft
HTL65-WW	24V DC	3000K	16.4 ft	270Lm / ft	4.6W / ft	IP65	96+	3.94" (100mm)	22 ft
HTL-WW-100	24V DC	3000K	100 ft	300Lm / ft	4.6W / ft	IP54	96+	3.94" (100mm)	22 ft
HTL-WH	24V DC	4000K	16.4 ft	310Lm / ft	4.6W / ft	IP54	96+	3.94" (100mm)	22 ft

16.4ft Reels (IP54) Include: 6ft lead, 6ft tail, (1) TL-CONKIT, (2) TL-BLKS, (2) TL-2PWR-HD
16.4ft Reels (IP65) Include: 2ft Lead +6" Conkit, 2ft Tail +6" Conkit, (2) TL-2PWR-HD
100ft Reels (IP54) Include: 6ft lead, 6ft tail, (1) TL-CONKIT, (3) TL-BLKS, (3) TL-2PWR-HD

HTL SERIES ACCESSORIES

ITEM NUMBER	DESCRIPTION
TL-CONKIT	6' Trulink 4-in-1 Connection Kit
TL-BLKS	Trulink 4-in-1 Connector Block (QTY 10)
TL-2PWR-HD	6' HD Power Feed (IP54)
TL-2JUMP6-HD	6" HD Linking Cable (IP54)
TL-2JUMP24-HD	24" HD Linking Cable (IP54)
TL-2SPL-HD	HD Tape to Tape Splice Connector (IP54)
TL-2SPL-L-HD	90° "L" HD Tape to Tape Splice Connector (IP54)
TL-2JUMP65-.5	6" Linking Cable (IP65)
TL-2JUMP65-1	12" Linking Cable (IP65)
TL-2JUMP65-2	24" Linking Cable (IP65)
WIRE-15-2PIN	15ft (20/2) Wire Spool
WIRE-CMP-100-3PIN	100ft (16/3) In-wall Rated Wire Spool
INLINE-SC-CTRL	Simple Select In-line Controller (Single Color)
LVS-2PIN	In-Line Splice Terminal Block
RCWY-PVC-1M	1m Plastic Wire Cover Raceway (White)

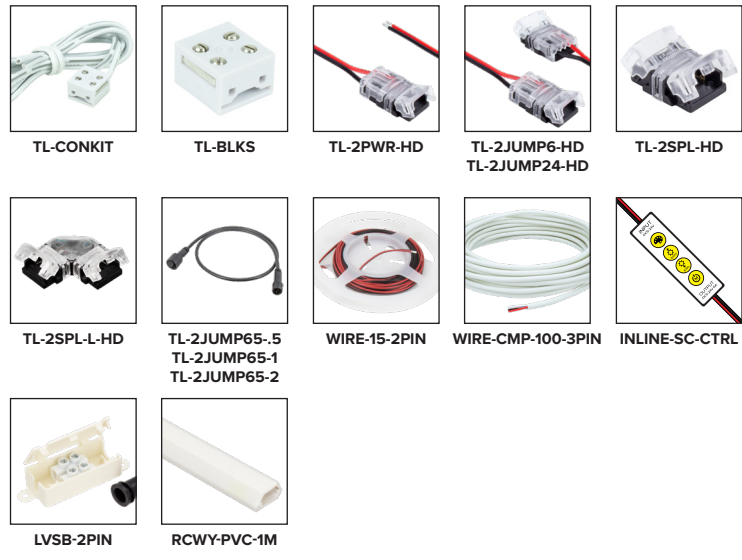

RECOMMENDED POWER SUPPLIES

ITEM NUMBER	DESCRIPTION	MAX / MIN LOAD	INPUT VOLTAGE	OUTPUT VOLTAGE	DIMMABLE	DIMENSIONS
ADPT-DRJ-30-24	Adaptive Series 30W	30W / 3W	100-277V AC	24V DC	Yes*	6.49"L x 3.6"W x 1.02"H
ADPT-DRJ-60-24	Adaptive Series 60W	60W / 6W	100-277V AC	24V DC	Yes*	7.4"L x 3.6"W x 1.02"H
ADPT-DRJ-96-24	Adaptive Series 96W	96W / 9.6W	100-277V AC	24V DC	Yes*	8.66"L x 3.6"W x 1.61"H
ADPT-DRJ-192-24	Adaptive Series 192W (2 x 96W)	192W / 19.2W	100-277V AC	24V DC	Yes*	10.94"L x 4.25"W x 1.8"H
ADPT-DRJ-288-24	Adaptive Series 288W (3 x 96W)	288W / 28.8W	100-277V AC	24V DC	Yes*	11.85"L x 4.25"W x 1.8"H

Phase Dimming Compatible With Most MLV, ELV, and TRIAC Dimmers

HTL SERIES QUICK SET-UP

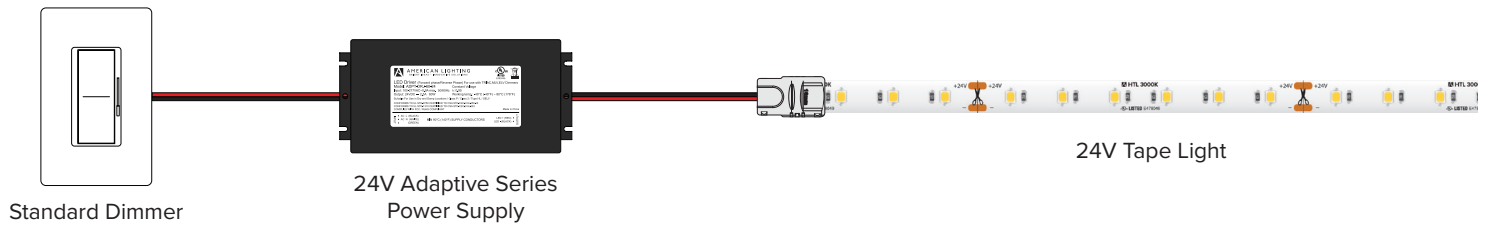

HTL SERIES CUT INCREMENT GUIDE

Segment	Length (MM)	Length (Inches)	Length (Feet)
1	100	3.94	0.33
2	200	7.88	0.66
3	300	11.82	0.99
4	400	15.76	1.31
5	500	19.7	1.64
6	600	23.64	1.97
7	700	27.58	2.30
8	800	31.52	2.63
9	900	35.46	2.96
10	1000	39.4	3.28
11	1100	43.34	3.61
12	1200	47.28	3.94
13	1300	51.22	4.27
14	1400	55.16	4.60
15	1500	59.1	4.93
16	1600	63.04	5.25
17	1700	66.98	5.58
18	1800	70.92	5.91
19	1900	74.86	6.24
20	2000	78.8	6.57
21	2100	82.74	6.90
22	2200	86.68	7.22
23	2300	90.62	7.55
24	2400	94.56	7.88
25	2500	98.5	8.21
26	2600	102.44	8.54
27	2700	106.38	8.87
28	2800	110.32	9.19
29	2900	114.26	9.52
30	3000	118.2	9.85
31	3100	122.14	10.18
32	3200	126.08	10.51
33	3300	130.02	10.84
34	3400	133.96	11.16
35	3500	137.9	11.49

Segment	Length (MM)	Length (Inches)	Length (Feet)
36	3600	141.84	11.82
37	3700	145.78	12.15
38	3800	149.72	12.48
39	3900	153.66	12.81
40	4000	157.6	13.13
41	4100	161.54	13.46
42	4200	165.48	13.79
43	4300	169.42	14.12
44	4400	173.36	14.45
45	4500	177.3	14.78
46	4600	181.24	15.10
47	4700	185.18	15.43
48	4800	189.12	15.76
49	4900	193.06	16.09
50	5000	197	16.42
51	5100	200.94	16.75
52	5200	204.88	17.07
53	5300	208.82	17.40
54	5400	212.76	17.73
55	5500	216.7	18.06
56	5600	220.64	18.39
57	5700	224.58	18.72
58	5800	228.52	19.04
59	5900	232.46	19.37
60	6000	236.4	19.70
61	6100	240.34	20.03
62	6200	244.28	20.36
63	6300	248.22	20.69
64	6400	252.16	21.01
65	6500	256.1	21.34
66	6600	260.04	21.67
67	6700	263.98	22.00

COMPATIBLE MOUNTING CHANNELS 10mm



ECONOMY

EE1-AAFR

Dimensions: 5/8" (16mm) W
x 1/4" (7mm) H

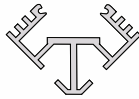

ECONOMY 45

EE45-AAFR

Dimensions: 3/4" (19mm) W
x 3/4" (19mm) H

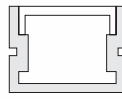

UNIVERSAL

PE-AA2 / PE-UNV

Dimensions: 16/25" (16mm) W
x 47/100" (12mm) H



UNIVERSAL MINI

PE-AA1 / PE-UNV MINI

Dimensions: 19/32" (15mm) W
x 1/4" (6mm) H

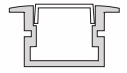

DOUBLE FLANGE

PE-AA2DF

Dimensions: 5/8" (16mm) W
x 7/16" (11mm) H



MINI DOUBLE FLANGE

PE-AA1DF

Dimensions: 19/32" (15mm) W
x 5/32" (4mm) H

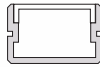

GT

PE-GT

Dimensions: 3/4" (19mm) W
x 1/2" (12mm) H

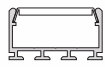

GTX

PE-GTX

Dimensions: 1" (26mm) W
x 9/16" (14.5mm) H

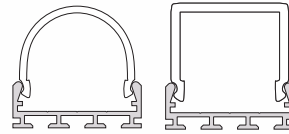

TURBO

PE-TURBO2

Dimensions: 1" (26mm) W x 1" (25mm) H

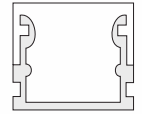

TRACE

PE-TRACE

Dimensions: 13/16" (21mm) W
x 13/16" (21mm) H

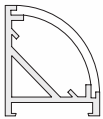

RADIUS

PE-RAD

Dimensions: 25/32" (20mm) W
x 29/32" (23mm) H

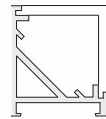

RUBIK

PE-RUBIK

Dimensions: 29/32" (23mm) W
x 25/32" (20mm) H



STANT

PE-SSTANT

Dimensions: 1-3/16" (30mm) W
x 1/4" (7mm) H



TRIPLE STANT

PE-3STANT

Dimensions: 2-11/32" (59mm) W
x 3/8" (9mm) H



DYAD

PE-DYAD

Dimensions: 1.35" (34.2mm) W
x 0.47" (12mm) H



CAMBER

PE-CMBR

Dimensions: 0.71" (18mm) W x
0.23" (5.7mm) H

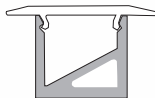

BEVEL 28

PE-B28

Dimensions: .47" (12mm) W
x .47" (12mm) H

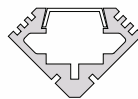

PREMIUM 45

PE-AA45

Dimensions: 3/4" (19mm) W
x 3/4" (19mm) H



PRO 45

PE-PRO45

Dimensions: 1-3/16" (30mm) W
x 7/16" (10mm) H

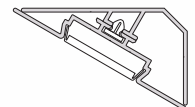

PRO 30

PE-PRO30

Dimensions: 1-13/16" (46mm) W
x 1-1/16" (27mm) H

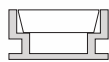

HELM

PE-HELM

Dimensions: 13/16" (20mm) W
x 11/32" (8.5mm) H

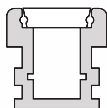

PAVER

PE-PAVER

Dimensions: 1" (26mm) W
x 1" (26mm) H

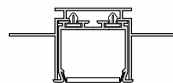

MINI FLANGE SLOT

PE-SLOT

Dimensions: 1-3/16" (30mm) W
x 15/16" (24mm) H

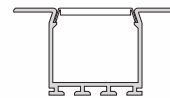

STANDARD FLANGE SLOT

PE-DFSLOT

Dimensions: 1" (25mm) W
x 15/16" (24mm) H

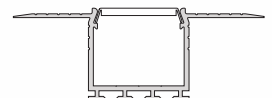

INVISIBLE SLOT

PE-INVSLT

Dimensions: 1-1/16" (27mm) W
x 15/16" (24mm) H



VERGE

PE-VERGE

Dimensions: 4.85" (123.83mm) W
x 25/64" (10mm) H

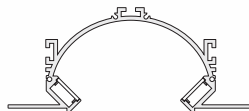

ARC

PE-ARC

Dimensions: 4-13/16" (122.4mm) W
x 2" (50.8mm) H



SCOOP WW

PE-SWW

Dimensions: .54" (13.59mm) W
x 3.79" (96mm) H

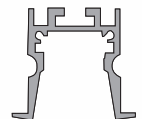

REGAL REGRESS

PE-REG

Dimensions: 1.16" (29.49mm) W
x 1.03" (26.25mm) H



STRUT:

PE-STRUT

Dimensions: 5/8" (15.5mm) W
x 1-3/8" (29.89mm) H

NOTES ON CLOSET LIGHTING

Closet Lighting | NEC 410.16 | Brief Overview

Please see 2026 NFPA NEC Code Book Section 41.16 for details code requirements

Do Closets Need Lighting?

- Not required by the NEC Code
- If installed, lighting must comply with NEC 410.1

Why Closet Lighting Is Regulated

- Clothing, fabric, and paper materials can be combustible
- Tight spaces increase fire risk
- Rules protect people and property
-

Approved Fixture Types

- Surface-mounted or recessed LED or incandescent
- Light source must be fully enclosed
- Fluorescent fixtures allowed
- Fixtures labeled for closet use are preferred
- Open or partially exposed bulbs are not allowed including pendants

What Counts as “Storage Space”?

- From floor to 6ft high or highest hanging rod
 - 24in out from side and back walls
 - Above shelves, up to ceiling within 12in of wall or shelf depth
 - 12in on each side of double-sided hanging rods
- Fixtures must stay outside this space unless specifically rated.

Minimum Clearance Requirements

From storage space:

- 12 in → Surface-mounted enclosed LED/incandescent
- 6 in → Recessed enclosed LED/incandescent

Benefits of Surface-Mounted vs. Recessed

Surface-Mounted

- Easy install
- Ideal for shallow closets
- Flexible placement

Recessed

- Clean, modern look
- No protrusions
- Requires wall/ceiling depth

Wiring & Controls

- Wiring must meet NEC standards
- Conductors must be protected
- Light switch should be near the entrance

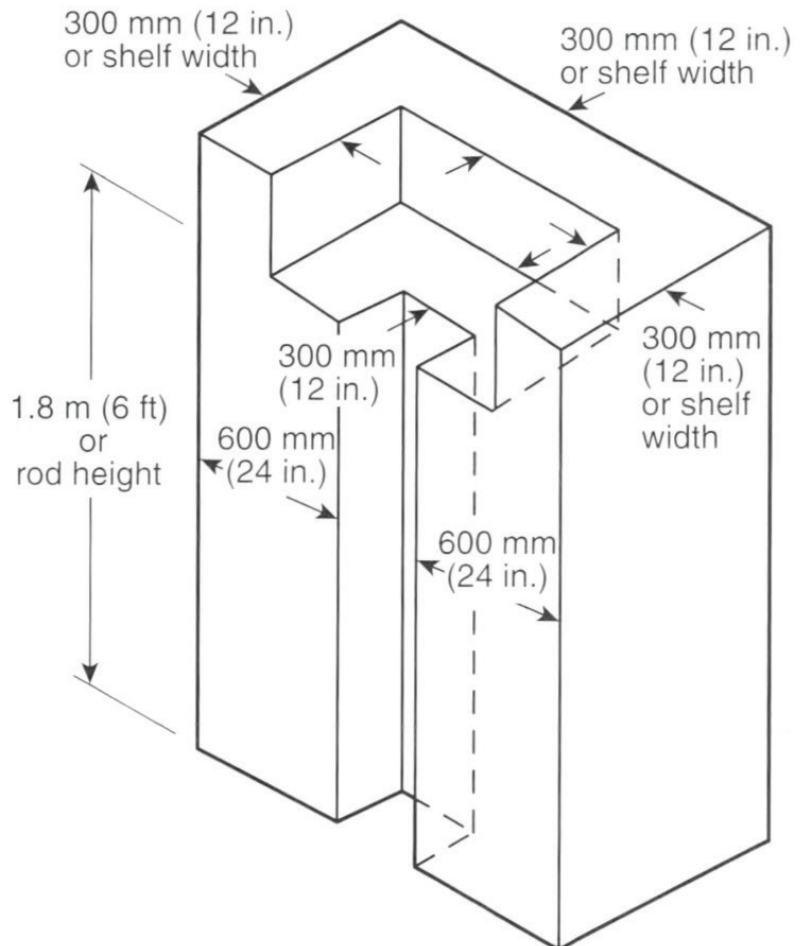
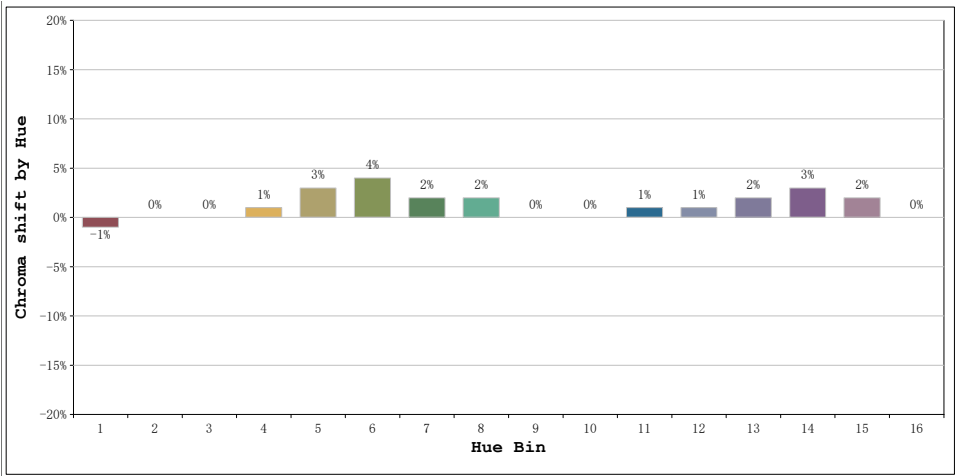
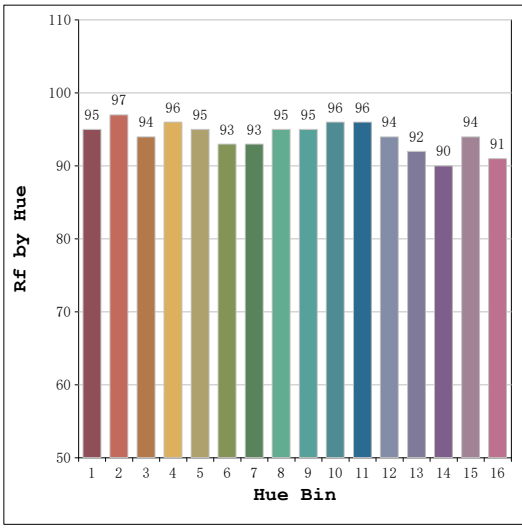
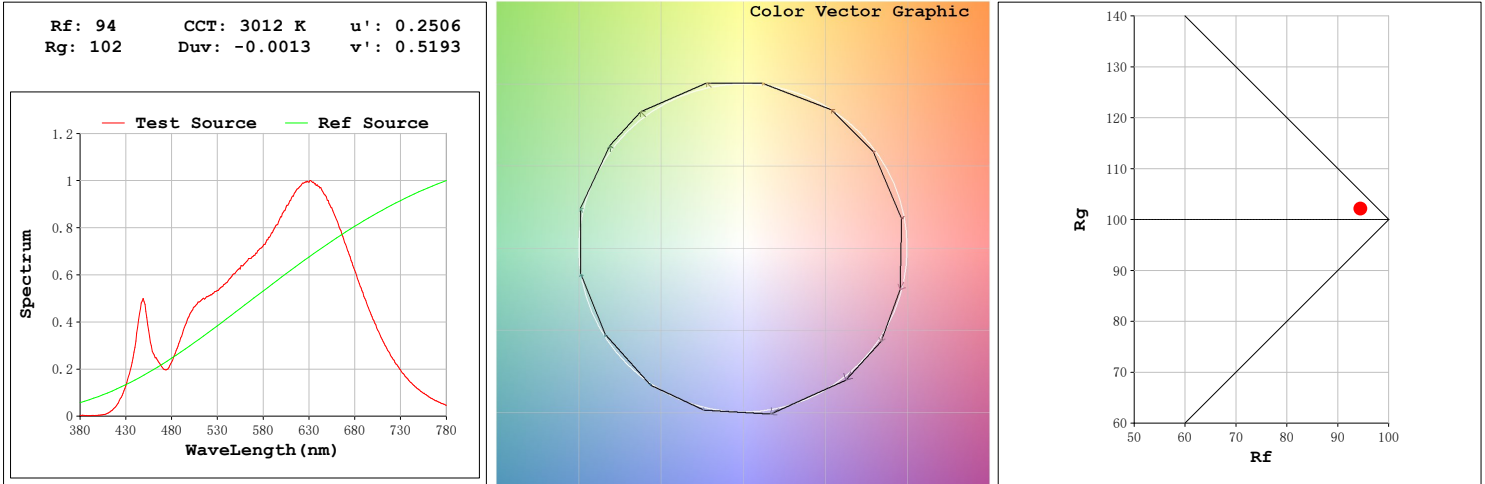

FIGURE 410.16(A) Clothes Closet Storage Space.

HTL SERIES TM-30 DATA - 3000K



Hue Bin	Hue Angle	Rf	Graphic shift(%)	
			Chroma	Hue
1	0.0° - 22.5°	95	-1	0
2	22.5° - 45.0°	97	0	1
3	45.0° - 67.5°	94	0	3
4	67.5° - 90.0°	96	1	2
5	90.0° - 112.5°	95	3	2
6	112.5° - 135.0°	93	4	1
7	135.0° - 157.5°	93	2	-2
8	157.5° - 180.0°	95	2	-1
9	180.0° - 202.5°	95	0	-1
10	202.5° - 225.0°	96	0	0
11	225.0° - 247.5°	96	1	1
12	247.5° - 270.0°	94	1	0
13	270.0° - 292.5°	92	2	-5
14	292.5° - 315.0°	90	3	-4
15	315.0° - 337.5°	94	2	-3
16	337.5° - 360.0°	91	0	-4



AMERICAN LIGHTING WARRANTY

LIMITED WARRANTY FOR LED PRODUCTS: 5 YEARS

AVERAGE LIFE

Average incandescent lamp life, rated life and average life are terms used to describe the number of hours at which half of the lamps have failed. For LEDs, the hours of rated life specify the point at which 70% of original lumen output is reached. Below this point, the effective life is over, however, the LED may still emit light. Individual results may vary with actual environmental conditions including, but not limited to, proper installation, ambient temperature and/or input voltage fluctuations.

Warranty life based on average 8 hours/day use, 7 days/week. Product should be cycled off for at least 6 hours per day.

SAFETY

You must disconnect lighting products from the power supply before servicing or replacing bulbs. Only qualified personnel should install and perform service on lighting products. Periodic inspection and maintenance is required to keep equipment operating properly and at peak performance. Do not mount fixtures on or adjacent to combustible materials.

Lighting products may present a possible shock or fire hazard if improperly installed or attached in any way. Products should always be installed in accordance with their instruction manuals, current electrical codes, and/or the current National Electric Code (NEC). Code compliance is the sole responsibility of the person, company, or party performing the installation of product. Failure to comply with national and/or regional safety codes may result in hazardous or dangerous conditions, damage to property or life, and/or altered product performance/specifications.

LIMITED PRODUCT WARRANTY

Our products are warranted to be free from defects in material and workmanship for the warranty period listed on the reverse by product category. Warranty periods begin from the date of shipment from American Lighting Inc's warehouse to the original purchaser. Products that prove to be defective during their specific warranty period will be either repaired or replaced, at the sole discretion of American Lighting Inc. Claims for defective products must be submitted in writing to American Lighting Inc's RGA Department within the warranty period. Upon approval of such return, American Lighting Inc reserves the right to inspect the product for misuse or abuse. Claims for indirect or consequential damages or for any product that, in American Lighting Inc's opinion, has been misused will be denied. This is a warranty of product reliability only and not a warranty of merchantability or fitness for a particular purpose. American Lighting Inc shall have no liability whatsoever in any event for payment of incidental or consequential damages, including, without limitations, installation costs and/or damages for personal injury and/or property. These products may represent a possible shock or fire hazard if improperly installed or altered in any way. This warranty does not apply to any product that has not been properly installed in accordance with current local codes and/or the National Electrical Code. Products that require a transformer, driver or power supply must be used in conjunction with American Lighting Inc's recommended power supply to ensure safety and retain product warranty. Limited Product Warranty applies to lengths up to 75 feet for rope light products.

STANDARD LINEAR WARRANTY

Rope light and linear lighting products in all their various types and shapes, whether LED or incandescent, are wired in series parallel. This means that several individual lamps or LEDs are wired together in series to equal 12V, 24V or 120V. Then these sections are wired together (in parallel) to light up in unison. If one solder joint, lamp or resistor fails, a whole section will not light. Due to the number of elements involved, and the numerous extenuating circumstances beyond our control, American Lighting Inc offers a Standard Linear Warranty on most linear lighting products. The limited liability warranty is listed above, however the Standard Linear Warranty offers replacement product by section due to defective material and/or workmanship for one year beginning from the date of shipment from American Lighting Inc's warehouse to the original purchaser.

USE OF LINEAR LIGHTING IN OUTDOOR APPLICATIONS

Incandescent rope light and LED Flexbrite UL 2388 custom cuts; incandescent and LED Flexbrite pre-packaged kits; and UL Listed (special order) cuts of LED Neon Flexbrite Plus and Economy have factory assembled power connections and end caps that seal the rope from moisture. Due to strict quality control standards, American Lighting is able to offer a limited warranty on these items rather than the standard linear lighting warranty that replaces product by defective section only. For outdoor applications, best practices include using kits interconnected (same length kits are best for color control of White LED Flexbrite) or using custom cuts that do not exceed 75 feet.

For all linear lighting categories, any non-rated field connection made in an outdoor application should be properly sealed with dielectric grease covering all conductive materials; and properly installed power connections and end caps, sealed with dielectric grease, silicone, and heat shrink tube. However, since non-rated (field executed) power connections of linear lighting products cannot be quality controlled, and outdoor use of non-rated product is not recommended, American Lighting cannot warrant the product to any purchaser.

PRODUCT SPECIFICATIONS

For the latest product information, updates, instructions and details concerning specifications, colors, finishes, performance, installation and design, visit www.americanlighting.com. Color may vary from the color printed herein due to limitations in photographic and printing processes. American Lighting Inc. reserves the right to change product specifications without notice. Other product specifications such as color temperature, wavelength characteristics and lumen output are subject to production limitations and may vary.

LED technology is changing rapidly, and not all color temperatures and performance levels can be duplicated at a later time.

Best practices include purchasing 10-15% additional product for a project on the same initial order where white LED color temperatures must be maintained over project and product life. Eventual product replacement should be considered at layout and design stages. Best practices also include testing connections and product performance prior to mounting and/or installing.