

ELEMENT™ 3" LED

ADJUSTABLE DOWNLIGHT

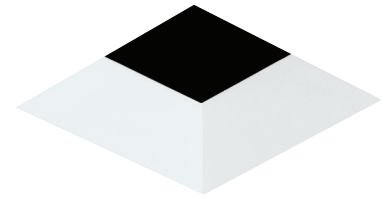

SHOWN IN FLANGELESS BEVEL SQUARE

The ELEMENT 3" Next Generation Adjustable recessed downlight features full adjustability with lockable, tool-free, hot aiming. ELEMENT's patented high/low lamp positioning allows the LED to be positioned closer to the aperture for maximum light output and efficiency or higher in the ceiling to minimize glare and flash on the trim. Options include premium warm dimming, tunable white, Xicato and Xicato Artist Series LED modules. Trim options include flanged or flangeless and flangeless in wood ceiling.

- Housing reduced by 60%
- Tool-free aiming/locking: 0-40° tilt, 361° rotation
- Patented high/low lamp positioning
- 2-step standard
- Standard dimming down to 1%
- Trims reflector options
- Solite Soft Focus lens option

LUMEN MULTIPLIER (CRI/CCT)

CCT	80 CRI MULTIPLIER	90 CRI MULTIPLIER
2700K	0.95	0.80
3000K	1.00	0.85
3500K	1.05	0.90

Lumen output will vary by CCT and CRI. See photometric charts for output information.

SPECIFICATIONS

	STATIC WHITE		XICATO		WARM DIM		TUNABLE WHITE	
	HIGH OUTPUT	LOW OUTPUT	STANDARD SERIES	ARTIST SERIES	HIGH OUTPUT	LOW OUTPUT	HIGH OUTPUT (5000K)	HIGH OUTPUT (4000K)
DELIVERED LUMENS	1800/1450	1319/1124	1129	945	1300	900	1272	1150
WATTS	17	12	15	15	17	12	18	18
EFFICACY	106/85	110/94	75	63	76	75	72	64
CRI	80+/90+		80+	95+	90+		90+	
CBCP	10° - 19,414 18° - 5,848 25° - 5,416 40° - 3,230 60° - 2,305		21° - 3,184 43° - 2,733 60° - 1,014		18° - N/A 25° - N/A 40° - 1,622 60° - N/A			
CCT	2700K, 3000K, or 3500K		2700K, 3000K, or 3500K ³		3000K - 1800K		5000K - 2700K	4000K - 1800K
COLOR CONSISTENCY	2-step		1 X 2-step		3-step		2-step	
VOLTAGE	120V or 277V							
DIMMING ¹	Standard reverse-phase, forward-phase, TRIAC, and 0-10V dimming (down to 1%) eldoLED 0-10V or DALI-2 (down to 0.1%) Lutron Hi-lume EcoSystem (down to 0.1%)						eldoLED 0-10V or DALI-2 (down to 0.1%)	
POWER SUPPLY	Constant current driver with +.9 power factor and +80% efficiency							
OPTICS	Field changeable: 10°, 18°, 25°, 40°, or 60° TIR		Field changeable: 21°, 43°, or 60° reflector		Field changeable: 18°, 25°, 40°, or 60° TIR			
ADJUSTABILITY	Lockable, hot-aiming 0-40° tilt, 361° rotation, high/low lamp positioning, 45° collar rotation							
CEILING APPEARANCE	Flanged, Flangeless or Flangeless in Wood Ceiling							
CEILING THICKNESS	Flanged: Up to 2-1/2" Flangeless: No ceiling thickness limitations Flangeless in Wood Ceiling: 1/2" to 1-1/2" Note: Thicker ceilings impact light cutoff							
CEILING APERTURE	3-7/8" ceiling cutout							
HOUSING	IC Airtight, Non-IC Airtight, Chicago Plenum. IC suitable up to R60 spray foam insulation. Sauna/steam-room use available only with combination of H shower trim, LO low output housing, and I IC housing rating.							
CONSTRUCTION	Housing: Heavy-gauge, cold-rolled steel Trim: Die-cast aluminum							
FINISH	Housing: Black Powder Coat Trim: Antique Bronze, Black, Satin Nickel, or White (paintable)							
GENERAL LISTINGS	ETL Listed. Damp Location. Shower version Wet Listed.							
CALIFORNIA TITLE 24	Registered CEC Appliance Database. Can be used to comply with CEC 2019 Title 24 Part 6 (JA8-2016, JA8-2019) (for 90 CRI versions).							
L70	50,000 hours min							
WARRANTY ²	5 years							

Data in chart reflect 3000K/80 CRI values unless noted.

Custom output/custom RAL/custom CCT available, contact Quotes Department

Ordering grids available on page 2.

¹See visualcomfort.com for dimmer compatibility.

²Visit visualcomfort.com for specific warranty limitations and details.

³3500K Xicato module not available for Artist series.

ELEMENT™ 3" LED

ADJUSTABLE DOWNLIGHT

ORDERING GRIDS

HOUSING

PRODUCT	CEILING APPEARANCE	OUTPUT	CRI/CCT	BEAM SPREAD	FUNCTION	HOUSING RATING	DRIVER
E3R ELEMENT 3" ROUND	LF FLANGELESS	-LH HIGH OUTPUT,	827 80 CRI, 2700K, 2-STEP	0 10° ⁵	A ADJUSTABLE	I IC AIRTIGHT	INTEGRATED DRIVERS 120V/277V
	FF FLANGED	17W²	830 80 CRI, 3000K, 2-STEP	1 18°			
E3S ELEMENT 3" SQUARE	WC WOOD CEILING ¹	-LO LOW OUTPUT,	835 80 CRI, 3500K, 2-STEP	2 25°	C CHICAGO PLENUM	E EMERGENCY	UNIVERSAL PHASE/0-10V 1% (LEAVE BLANK)⁶
		12W³	927 90 CRI, 2700K, 2-STEP	4 40°			
			930 90 CRI, 3000K, 2-STEP	6 60°			-ELDO ELDOLED 0.1% 0-10V LINEAR ⁷
			935 90 CRI, 3500K, 2-STEP				-ELDOA ELDOLED 0.1% 0-10V LOGARITHMIC ⁷
			WD 90 CRI, 3000-1800K, WARM DIM, 3-STEP				-ELDD ELDOLED 0.1% DALI-2 ⁷
			TW52 90 CRI, 5000K-2700K, TUNABLE WHITE, 2-STEP ⁴				-ELTO ELDOLED TUNABLE WHITE 0.1% 0-10V LINEAR ^{4,7}
			TW41 90 CRI, 4000K-1800K, TUNABLE WHITE, 2-STEP ⁴				-ELTD ELDOLED TUNABLE WHITE 0.1% DALI-24 ⁷
		-X XICATO, HIGH OUTPUT, 14W ⁸	I27 80 CRI, 2700K, 1X2-STEP, XICATO	21 21° XICATO			-HLECO LUTRON HI-LUME 0.1% ECOSYSTEM ⁷
			I30 80 CRI, 3000K, 1X2-STEP, XICATO	43 43° XICATO			
			I35 80 CRI, 3500K, 1X2-STEP, XICATO	60 60° XICATO			
			A27 95 CRI, 2700K, 1X2-STEP, XICATO ARTIST				
			A30 95 CRI, 3000K, 1X2-STEP, XICATO ARTIST				

Trims are required and must be ordered separately.

For dimming details, refer to dimmer compatibility chart.

¹WC - Wood ceiling option accommodates flangeless trims only.

²LH - High output available for wet applications. Not rated for Sauna/Steam-room.

³LO - Sauna/steam-room use available only with combination of H shower trim, LO low output housing, and I IC housing rating.

⁴TW52/TW41/ELTO/ELTD - Tunable white only available in high output, only available with ELTO (0-10V, linear), or ELTD (DALI-2). For 0-10V logarithmic dimming consult Quotes Department.

⁵0 - 10° optic has a unique LED module not available with warm dim or tunable white. Changing optics to 18°, 25°, 40° or 60°, will require a new LED module.

⁶Universal dimming is reverse-phase, forward-phase, TRIAC and 0-10V. 277V is only compatible with 0-10V dimming.

⁷Lutron Hi-lume and eldoLED drivers not compatible with round flangeless (E3RLF) or round wood ceiling (E3RWC) housings.

⁸X - Xicato housings utilize dedicated standard phase, 0-10V, 120V and 277V drivers. If ordering Xicato with standard drivers (non-Lutron or eldoLED), at the end of the item number please specify:

-010 for 0-10V 120V, **-277** for Phase 277V or **-010-277** for 0-10V 277. For example: E3RLF-XA2743DI-**010** or E3RLF-XA2743DI-**277** or E3RLF-XA2743DI-**010-277**. Due to the size of some of the Xicato Reflectors, it may not be feasible to tilt the fixture in the 'low' position. It is still tiltable in the 'high' position.

TRIM

PRODUCT	CEILING APPEARANCE	STYLE	APERTURE	FINISH
E3R ELEMENT 3" ROUND	L FLANGELESS	B BEVEL	-O NO LENS	Z ANTIQUE BRONZE
E3S ELEMENT 3" SQUARE	F FLANGED UP TO 1" CEILING THICKNESS	F FLAT	-H SHOWER ^{1,2}	B BLACK
	F15 FLANGED 1.1"-1.5" CEILING THICKNESS		-L LENSED ²	S SATIN NICKEL
	F20 FLANGED 1.6"-2.0" CEILING THICKNESS			W WHITE
	F25 FLANGED 2.1"-2.5" CEILING THICKNESS			

Wood ceiling option accommodates flangeless trims only.

¹H - Sauna/steam-room use available only with combination of H shower trim, LO output housing, and I IC housing rating.

²H, L - Lensed products come with Solite Soft Focus lens.

WALL WASH TRIM

PRODUCT ¹	CEILING APPEARANCE	STYLE	FINISH	LED
E3R ELEMENT 3" ROUND	L FLANGELESS	W WALL WASH	-Z ANTIQUE BRONZE	-LED
E3S ELEMENT 3" SQUARE	F FLANGED		-B BLACK	
			-S SATIN NICKEL	
			-W WHITE	
		W	-	-LED

¹Wall wash trims may be used to convert the ELEMENT Adjustable housing to a wall wash. For dedicated wall wash housings, refer to the ELEMENT 3" Wall Wash specification sheet.

REPLACEMENT OPTICS

PRODUCT	BEAM SPREAD
353E4LEDCOPT	18 18°
	25 25°
	40 40°
	60 60°

353E4LEDCOPT

REPLACEMENT REFLECTORS

PRODUCT ¹	BEAM SPREAD
352LEDXREF	21 21°
	43 43°
	60 60°

352LEDXREF

¹For use with Xicato modules only.

PREMIUM LENS HOLDER

PRODUCT	LENSES
240E3LENSHLDR	1 ONE LENS
	2 TWO LENSES

240E3LENSHLDR

Provides more secure mounting of additional lenses than the lens holder that ships with each fixture.
Not compatible with the 10° beam spread.

PLASTER PLATES

PRODUCT ¹	
150E3RPPLT-A	3" PLASTER PLATE ROUND DIE-CAST METAL ¹
150E3SPPLT-A	3" PLASTER PLATE SQUARE DIE-CAST METAL ¹
150E3RTPPLT-W	3" PLASTER PLATE ROUND SHEET METAL ²
150E3STPPLT-W	3" PLASTER PLATE SQUARE SHEET METAL ²

Used to convert flanged housings into flangeless housings.
¹Ships standard with flangeless housings. Round not compatible with Lutron Hi-lume or eldoLED drivers.
²Optional, thinner, meshed sheet-metal mud plates available for minimized plaster feathering to meet installer preference. Round not compatible with Lutron Hi-lume or eldoLED drivers. Square not compatible with eldoLED drivers.



ELEMENT™ 3" LED

ADJUSTABLE DOWNLIGHT

TRIMS

FLANGED

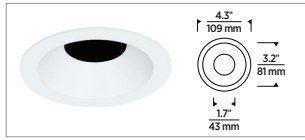

ROUND BEVEL

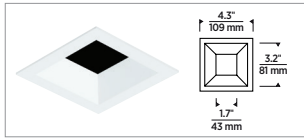

SQUARE BEVEL

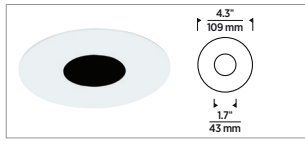

ROUND FLAT

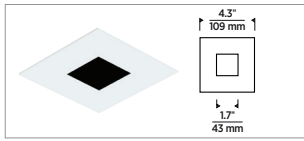

SQUARE FLAT

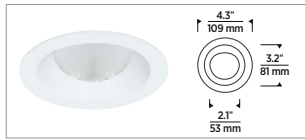

ROUND WALL WASH

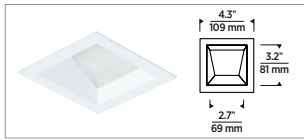

SQUARE WALL WASH

FLANGELESS

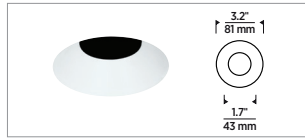

ROUND BEVEL

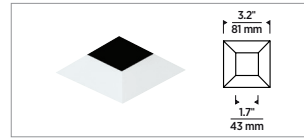

SQUARE BEVEL

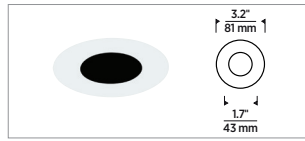

ROUND FLAT

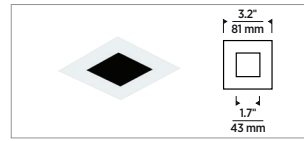

SQUARE FLAT



ROUND WALL WASH

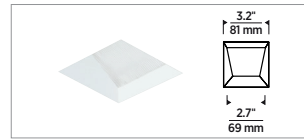

SQUARE WALL WASH

FINISH



ANTIQUE BRONZE



BLACK



SATIN NICKEL



WHITE (PAINTABLE)

FLANGELESS IN WOOD CEILING



ROUND BEVEL (ANTIQUE BRONZE)

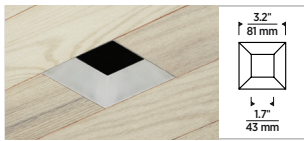

SQUARE BEVEL (SATIN NICKEL)



ROUND FLAT (ANTIQUE BRONZE)



SQUARE FLAT (SATIN NICKEL)



ROUND WALL WASH (ANTIQUE BRONZE)



SQUARE WALL WASH (SATIN NICKEL)

LENS OPTION



SHOWN WITH AND WITHOUT A LENS (SQUARE FLANGED BEVEL)

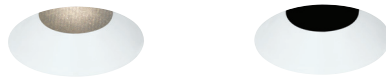

SHOWN WITH AND WITHOUT A LENS (ROUND FLANGELESS BEVEL)



ELEMENT™ 3" LED

ADJUSTABLE DOWNLIGHT

WARM DIM CURVE

CCT vs. Forward Current, $T_c=25^{\circ}\text{C}$

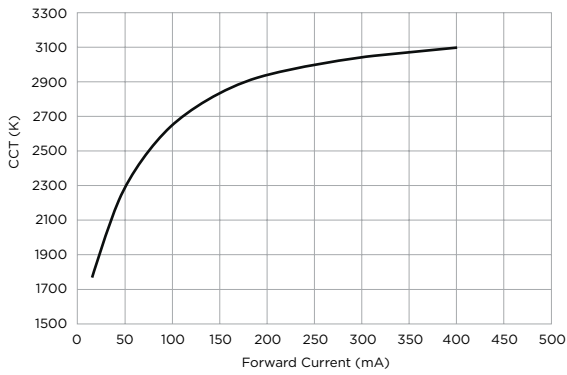

HOUSING

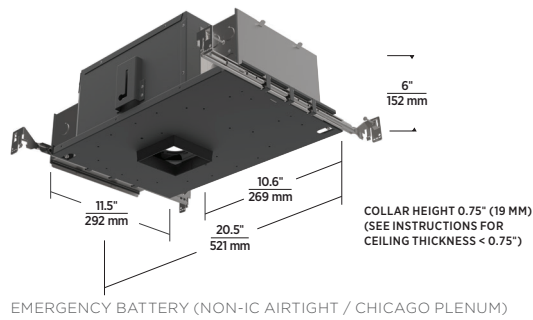
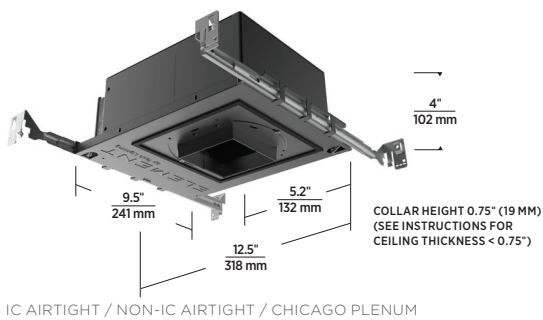

ELEMENT™ 3" LED ADJUSTABLE DOWNLIGHT

PLASTER PLATES

INCLUDED DIE-CAST

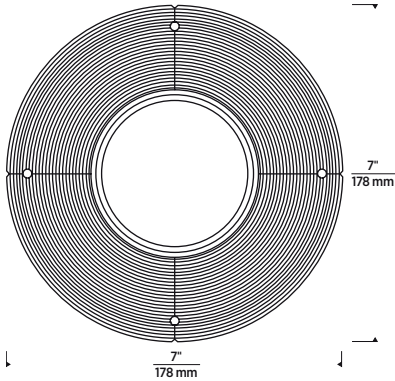

ROUND DIE-CAST (INCLUDED FOR FLANGELESS INSTALLATION)

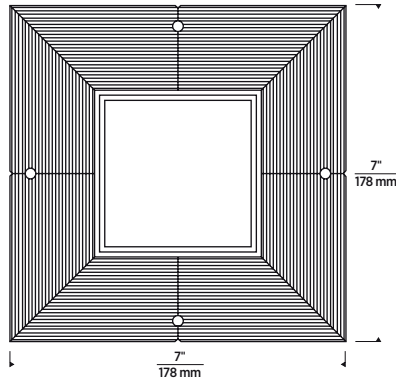

SQUARE DIE-CAST (INCLUDED FOR FLANGELESS INSTALLATION)

OPTIONAL SHEET METAL

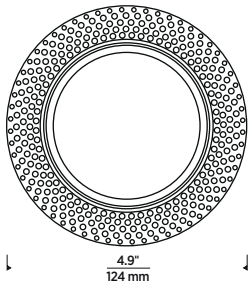

ROUND SHEET METAL (OPTIONAL FOR FLANGELESS INSTALLATION)

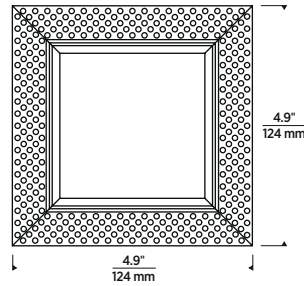

SQUARE SHEET METAL (OPTIONAL FOR FLANGELESS INSTALLATION)

FLANGELESS IN WOOD CEILING TRIM ADAPTER

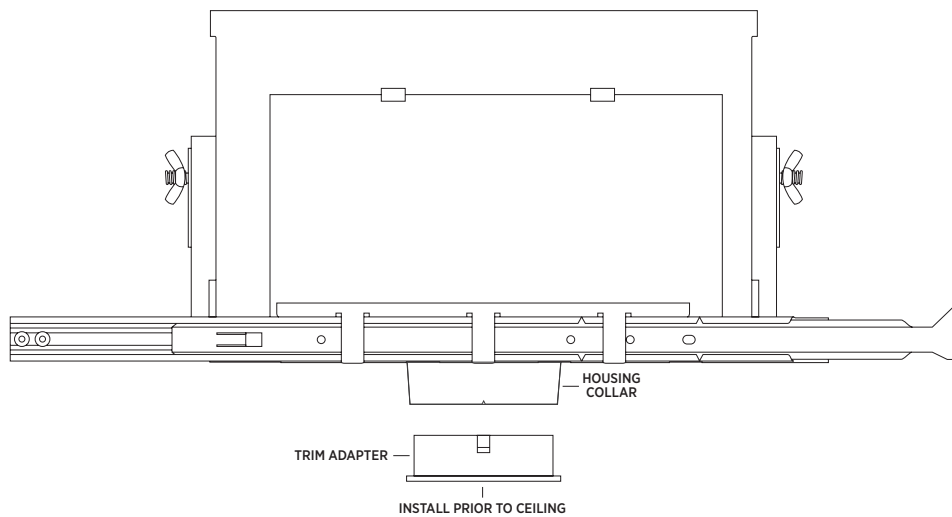

TRIM ADAPTER INSTALLED

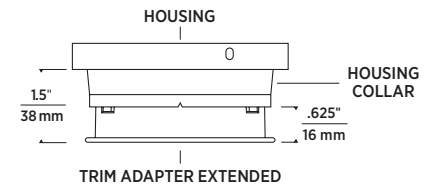
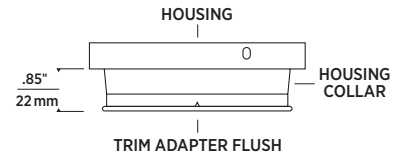

Wood ceiling housings ("WC" designation in the ordering grid) ship with an adjustable trim adapter that inserts into the housing aperture and allows standard ELEMENT 3" flangeless trims to achieve a truly flangeless, flush ceiling appearance in special applications such as wood or stone installation. For use in new construction. Consult installation instructions regarding plenum requirements and ceiling thickness ratios.

























ELEMENT™ 3" LED ADJUSTABLE DOWNLIGHT

TRIM-MOUNTED REFLECTORS

ELEMENT Specular Reflectors reduce glare while creating a clean, quiet ceiling appearance. Available finishes include Anodized Gold and Silver for a decorative accent or Anodized Black for an ultimate quiet ceiling aesthetic. These beautiful trim accessories have been specifically designed to minimize any effect on light performance, color, and output. Specular Reflectors are available for both Adjustable and Fixed downlights, and are compatible with ELEMENT 3" trims and housings.

- Can be easily installed or removed
- Assembles to existing trim
- Compatible with Fixed and Adjustable Housings
- Finish Options: Anodized Black (B) or Anodized Silver (S)

SPECIFICATIONS

COMPATIBLE TRIMS	NON-SLOTTED (FOR FIXED ¹)	SLOTTED (FOR ADJUSTABLE)
 3" round, flanged, bevel	 E3TREFNS1 (B OR S)	 E3TREFS4 (B OR S)
 3" square, flanged, bevel	 E3TREFNS5 (B OR S)	 E3TREFS1 (B OR S)
 3" round, flanged, flat	 E3TREFNS1 (B OR S)	 E3TREFS4 (B OR S)
 3" square, flanged, flat	 E3TREFNS3 (B OR S)	 E3TREFS2 (B OR S)
 3" round, flangeless, bevel	 E3TREFNS2 (B OR S)	 E3TREFS6 (B OR S)
 3" square, flangeless, bevel	 E3TREFNS6 (B OR S)	 E3TREFS5 (B OR S)
 3" round, flangeless, flat	 E3TREFNS4 (B OR S)	 E3TREFS3 (B OR S)
 3" square, flangeless, flat	 E3TREFNS3 (B OR S)	 E3TREFS2 (B OR S)

May require lamp to be placed in high position.
Not compatible with lensed trims.

¹Non-slotted reflectors may be used in adjustable housings with the lamp assembly placed in the 0° tilt position.

ORDERING GRID

E3 TRIM-MOUNTED REFLECTORS

PRODUCT	STYLE	FINISH
E3TREF	NS1 NON-SLOTTED	B ANODIZED BLACK S ANODIZED SILVER
	NS2 NON-SLOTTED	
	NS3 NON-SLOTTED	
	NS4 NON-SLOTTED	
	NS5 NON-SLOTTED	
	NS6 NON-SLOTTED	
	S1 SLOTTED	
	S2 SLOTTED	
	S3 SLOTTED	
	S4 SLOTTED	
	S5 SLOTTED	
	S6 SLOTTED	

E3TREF

Reflectors are placed on top of the inside of the trim or affixed via screws (only if provided).

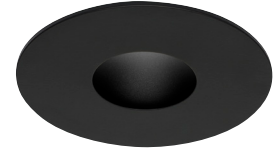

SHOWN IN ANODIZED BLACK
(BELOW CEILING VIEW)



SHOWN IN ANODIZED SILVER
(BELOW CEILING VIEW)



SHOWN IN ANODIZED SILVER
(BELOW CEILING VIEW)



SHOWN IN ANODIZED BLACK
(TRIM MOUNTED)



SHOWN IN ANODIZED BLACK AND
SILVER (REFLECTOR ONLY)

ELEMENT™ 3" LED

ADJUSTABLE DOWNLIGHT

PHOTOMETRICS

Description: 3" LED Module
10° Beam - 0° Tilt,
80 CRI, 3000K

Model: E3 Citizen LED

Input Power (Watts): 16.3

Input Power Factor: 0.98

Absolute Luminous Flux (Lumens): 1337

Lumen Efficacy (Lumens per Watt): 82

Description: 3" LED Module
18° Beam - 0° Tilt,
80 CRI, 3000K

Model: E3 Citizen LED

Input Power (Watts): 18.1

Input Power Factor: 0.98

Absolute Luminous Flux (Lumens): 1598

Lumen Efficacy (Lumens per Watt): 88.1

Description: 3" LED Module
25° Beam - 0° Tilt,
80 CRI, 3000K

Model: E3 Citizen LED

Input Power (Watts): 18.3

Input Power Factor: 0.98

Absolute Luminous Flux (Lumens): 1754

Lumen Efficacy (Lumens per Watt): 95.5

Output difference between CCTs - 5%, CRIs - 15%.

ANGLE	0°	45°	90°
0°	19414	19414	19414
5°	10254	10254	10254
10°	3511	3511	3511
15°	1342	1342	1342
20°	383	383	383
25°	126	126	126
30°	84	84	84
35°	54	54	54
40°	31	31	31
45°	22	22	22
50°	18	18	18
55°	11	11	11
60°	6	6	6
65°	3	3	3
70°	2	2	2
75°	0	0	0
80°	0	0	0
85°	0	0	0
90°	0	0	0

ANGLE	0°	45°	90°
0°	5848	5848	5848
5°	5500	5478	5491
10°	3919	3944	3905
15°	2103	2212	2149
20°	1058	1199	1075
25°	507	548	508
30°	250	237	250
35°	148	140	141
40°	93	98	94
45°	51	69	61
50°	33	46	37
55°	21	27	24
60°	4	15	10
65°	2	3	2
70°	2	2	2
75°	0	0	0
80°	0	0	0
85°	0	0	0
90°	0	0	0

ANGLE	0°	45°	90°
0°	5422	5416	5427
5°	4916	4872	4888
10°	3800	3718	3721
15°	2040	2115	2016
20°	870	979	900
25°	400	441	414
30°	190	190	196
35°	103	103	105
40°	60	65	61
45°	27	43	31
50°	16	25	17
55°	7	12	7
60°	2	5	2
65°	2	2	2
70°	1	1	2
75°	0	0	0
80°	0	0	0
85°	0	0	0
90°	0	0	0

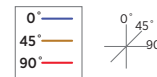
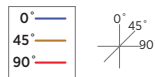
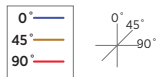
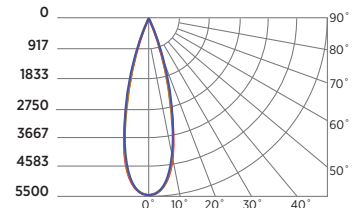
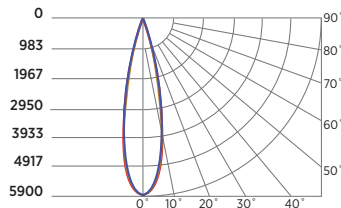
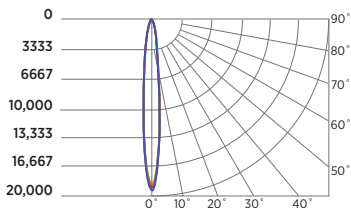
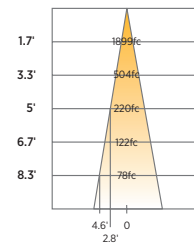
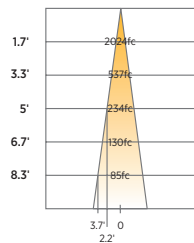
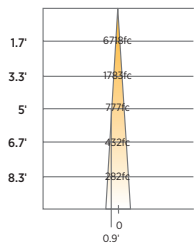

ELEMENT™ 3" LED

ADJUSTABLE DOWNLIGHT

PHOTOMETRICS

Description: 3" LED Module
 40° Beam - 0° Tilt,
 80 CRI, 3000K

Model: E3 Citizen LED

Input Power (Watts): 16.9

Input Power Factor: 0.98

Absolute Luminous

Flux (Lumens): 1774

Lumen Efficacy

(Lumens per Watt): 104.6

Output difference between CCTs - 5%, CRIs - 15%.

Description: 3" LED Module
 60° Beam - 0° Tilt,
 80 CRI, 3000K

Model: E3 Citizen LED

Input Power (Watts): 18.4

Input Power Factor: 0.98

Absolute Luminous

Flux (Lumens): 1536

Lumen Efficacy

(Lumens per Watt): 83.5

ANGLE	0°	45°	90°
0°	3230	3230	3230
5°	3107	3126	3159
10°	2824	2830	2871
15°	2415	2407	2463
20°	1863	1866	1937
25°	1111	1125	1128
30°	490	521	479
35°	221	232	205
40°	115	114	110
45°	65	64	59
50°	30	38	22
55°	14	22	11
60°	6	9	4
65°	1	3	1
70°	1	1	1
75°	1	1	1
80°	0	0	0
85°	0	0	0
90°	0	0	0

ANGLE	0°	45°	90°
0°	2305	2305	2305
5°	2313	2298	2268
10°	2295	2248	2155
15°	2219	2116	1938
20°	1964	1876	1714
25°	1548	1544	1330
30°	1113	1176	1013
35°	749	835	704
40°	450	511	428
45°	230	283	221
50°	94	140	91
55°	38	69	35
60°	18	31	16
65°	8	13	6
70°	0	4	0
75°	0	0	0
80°	0	0	0
85°	0	0	0
90°	0	0	0

