

ENTRA™ 3" LED

ADJUSTABLE DOWNLIGHT & WALL WASH

The ENTRA 3" Adjustable LED downlight offers a cost-effective alternative to meet residential and commercial specifications on budget-sensitive projects. Custom engineered for high performance and reliability, ENTRA is easy to configure with a complete feature set that offers flexibility without an overwhelming list of options. ENTRA LED modules are available in high or low output, with 4 color temperatures and include 20°, 40°, and 65° interchangeable optics with hot-aiming (30° tilt; 359° rotation). Flanged or flangeless (includes mud plate), round or square, flat or beveled die-cast trims in Black or a paintable White finish. Remodel installation also available with same performance and trim options.

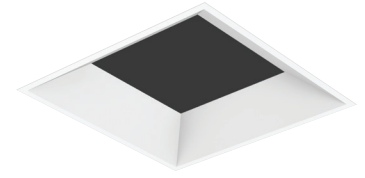

SHOWN IN FLANGELESS BEVEL SQUARE

- Hot-aiming (30° tilt; 359° rotation)
- Flanged or flangeless ceiling appearance
- 20°, 40°, and 65° interchangeable optics (all included)
- Accepts 2 optical controls
- Warm color dimming 3000K-1800K
- 2-step color binning

LUMEN MULTIPLIER (CRI/CCT)

CCT	90 CRI MULTIPLIER
2700K	0.95
3000K	1.00
3500K	1.05
4000K	1.07

SPECIFICATIONS

	HIGH OUTPUT	LOW OUTPUT	WARM DIM	
			HIGH	LOW
DELIVERED LUMENS	1311	980	925	715
WATTS	18	12	18	12
EFFICACY	73	82	49	59
CRI	90			
CBCP (AT 3000K)	20° - 4,994 40° - 2,544 65° - 1,091			
CCT	2700K, 3000K, 3500K, or 4000K		3000K - 1800K	
COLOR CONSISTENCY	2-step			
VOLTAGE	Universal 120V or 277V			
DIMMING ¹	Standard reverse-phase, forward-phase, TRIAC, and 0-10V dimming (down to 5%)			
POWER SUPPLY	Constant current driver with +.9 power factor and >87% efficiency			
OPTICS	20°, 40°, and 65° (included)			
ADJUSTABILITY	0-30° tilt, 359° rotation			
CEILING APPEARANCE	Flanged or flangeless			
CEILING THICKNESS	Flanged or flangeless: 1/2" to 1.5"			
CEILING APERTURE	4" ceiling cutout			
HOUSING	IC Airtight, Chicago Plenum. IC suitable up to R60 spray foam insulation.			
CONSTRUCTION	Housing: Heavy-gauge, cold-rolled steel Trim: Die-cast aluminum			
FINISH	Housing: Black powder coat Trim: Black or White (paintable)			
GENERAL LISTINGS	ETL listed, Damp Location. Shower version Wet Listed.			
CALIFORNIA TITLE 24	Registered CEC Appliance Database. Can be used to comply with CEC 2019 Title 24 Part 6 (JA8-2016, JA8-2019).			
L70	50,000 hours min			
WARRANTY ²	5 years			

Data in chart reflect 3000K/90 CRI values unless noted.

Ordering grids available on page 2.

Accepts two optical controls and an optional trim-mounted lens.

¹See visualcomfort.com for dimmer compatibility.

²Visit visualcomfort.com for specific warranty limitations and details.

ENTRA™ 3" LED

ADJUSTABLE DOWNLIGHT & WALL WASH

ORDERING GRIDS

HOUSING

PRODUCT	LAMP	CRI	TEMPERATURE	BEAM	FUNCTION	HOUSING RATING
EN3R ENTRA 3" ROUND	-LH HIGH OUTPUT	9 90 CRI	27 2700K	A 20° - 40° - 65° ²	A ADJUSTABLE ³	I IC AIRTIGHT
EN3S ENTRA 3" SQUARE	-LO LOW OUTPUT ¹		30 3000K			C CHICAGO PLENUM
			35 3500K			
			40 4000K			
			WD WARM DIM (3000K-1800K)			
	-	9		A	A	

Includes an LED driver with universal input 120V-277V, dimmable by reverse-phase, forward-phase, TRIAC, or 0-10V controls. 277V is only compatible with 0-10V dimming. Housing ships with plaster plate for use on Flangeless installation. Do not use plate for flanged installs.

Trims are required and must be ordered separately.

¹LO - Sauna/steam-room use available only with combination of low output housing (-LO) and shower trim (-H or -S).

²A - LED module ships with 40° optic installed. Includes 20° and 65° optics as well.

³A - Use with 40° optic and adjust to 30° tilt for wall wash.

TRIM

PRODUCT	CEILING APPEARANCE	STYLE	APERTURE	FINISH
EN3R ENTRA 3" ROUND	L FLANGELESS	B BEVEL	-O NO LENS	B BLACK ¹
EN3S ENTRA 3" SQUARE	L15 FLANGELESS 1" - 1.5" CEILING THICKNESS ¹	F FLAT	-H SHOWER (SANDBLASTED LENS) ^{1,3}	W WHITE (PAINTABLE)
	F FLANGED 0.5" - 0.75" CEILING THICKNESS	W WALL WASH ²	-S SHOWER (SOLITE LENS) ³	
	F1 FLANGED 0.75" - 1" CEILING THICKNESS		-W WALL WASH (LENSED) ²	
	F15 FLANGED 1" - 1.5" CEILING THICKNESS ¹			

¹H - Sandblasted shower lens not available with L15 - flangeless 1"-1.5" ceiling thickness, F15 - flanged 1"-1.5" ceiling thickness, or B - Black trim.

²W - Wall wash style trim can only be used with wall wash lensed aperture (-W). For 1" max ceiling thickness. Wall wash not available with thicker ceiling trims - L15 and F15 - as standard. Available through quotes as custom.

³H, S - Shower (Sandblasted lens or Solite lens) aperture requires bevel trim (B). Sauna/steam-room use available only with combination of low output housing (-LO) and shower trim (-H or -S).

LENSES/LOUVERS¹

PRODUCT	
140MR16SF	SOLITE SOFT FOCUS LENS
140MR16SB	SANDBLASTED LENS
140MR16LL	LINEAR SPREAD LENS
140MR16DF	DIFFUSER SPREAD LENS
140MR16GL	CLEAR GLASS LENS
700A02-BK	EGGCRATE/HEXCELL LOUVER

¹For additional lenses, louvers, optical controls and accessories, reference visualcomfort.com. Lens/louvers mounted to lamp assembly only (max 2).

PLASTER PLATES

PRODUCT	
150EN3RPPLT	ROUND STANDARD PLASTER PLATE ¹
150EN3SPPLT	SQUARE STANDARD PLASTER PLATE ¹
150EN3RDCPPLT-A	ROUND DIE-CAST METAL PLASTER PLATE ²
150EN3SDCPPLT-A	SQUARE DIE-CAST METAL PLASTER PLATE ²

Plaster plates are used to convert flanged housings into flangeless housings.

¹Ships standard with all ENTRA 3" housings.

²Optional, durable die-cast design eliminates warping for a smooth, seamless appearance. Counter-sunk screw holes simplify mudding and sanding.

Integrated gunsights ensure optimal trim alignment.



ENTRA™ 3" LED

ADJUSTABLE DOWNLIGHT & WALL WASH

TRIMS

FLANGED

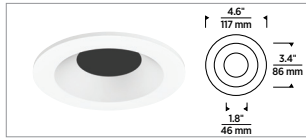

ROUND BEVEL

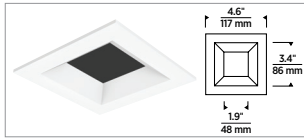

SQUARE BEVEL

FLANGELESS

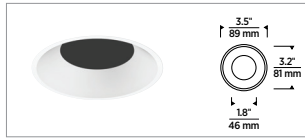

ROUND BEVEL

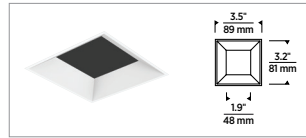

SQUARE BEVEL

FINISH

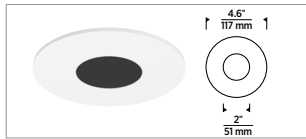

ROUND FLAT

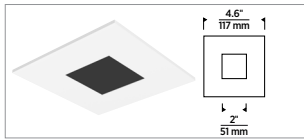

SQUARE FLAT

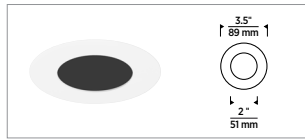

ROUND FLAT

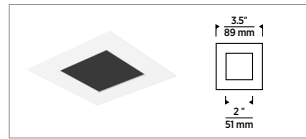

SQUARE FLAT

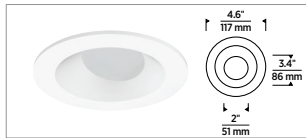

ROUND WALL WASH

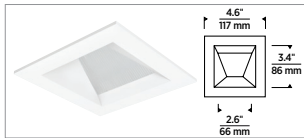

SQUARE WALL WASH



ROUND WALL WASH

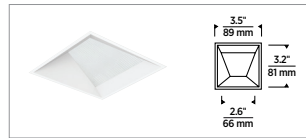

SQUARE WALL WASH

HOUSING

HIGH OUTPUT

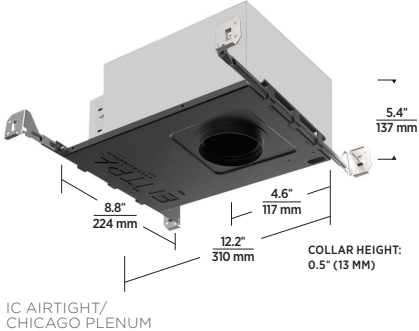

LOW OUTPUT

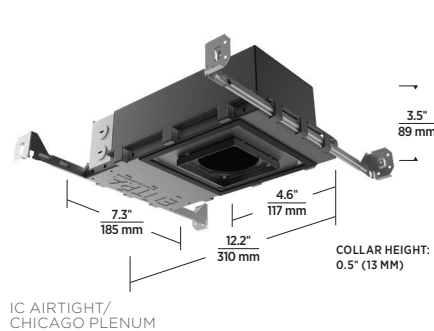

ENTRA™ 3" LED

ADJUSTABLE DOWNLIGHT & WALL WASH

PLASTER PLATES

INCLUDED PLASTIC

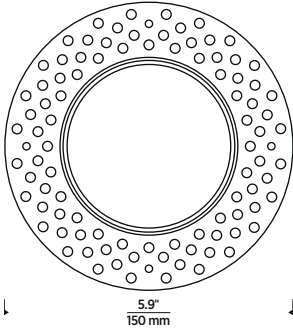

ROUND PLASTIC
(INCLUDED FOR FLANGELESS INSTALLATION)

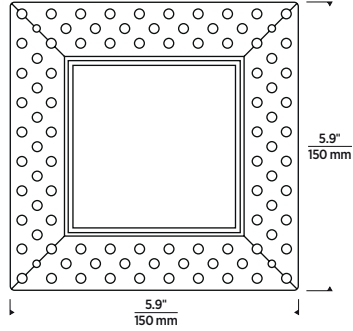

SQUARE PLASTIC
(INCLUDED FOR FLANGELESS INSTALLATION)

OPTIONAL DIE-CAST

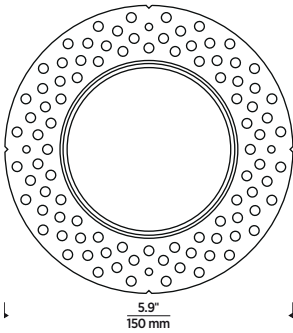

ROUND DIE-CAST

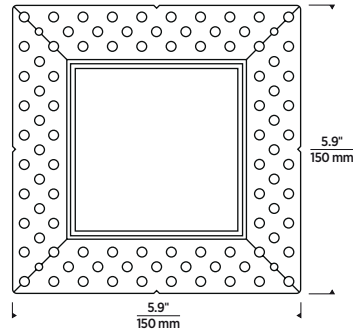

SQUARE DIE-CAST

DRIVER

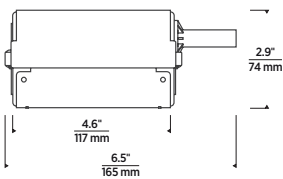

ENTRA™ 3" LED

ADJUSTABLE DOWNLIGHT & WALL WASH

WALL WASH PERFORMANCE

2' FROM WALL

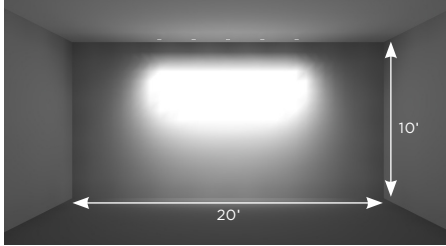

2' ON CENTER, 5 FIXTURES

2.5' FROM WALL

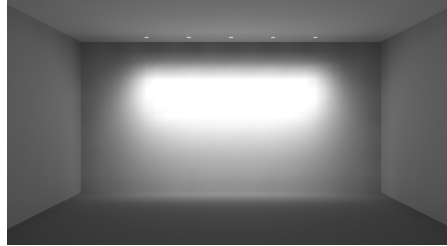

2.5' ON CENTER, 5 FIXTURES

3' FROM WALL

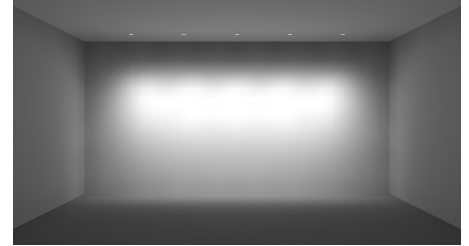

3' ON CENTER, 5 FIXTURES

FOOT-CANDLES ON WALL FROM MULTIPLE FIXTURES

HEIGHT ON WALL	2' FROM WALL								
	┌-2'-┐ on center		┌-2.5'-┐ on center		┌-3'-┐ on center				
10'	25.8	28.2	25.8	28.4	18.8	28.4	29	12.4	29
9'	43.8	53.2	43.8	48.9	40	48.9	50.8	28.6	50.8
8'	32.2	41.6	32.2	33.6	34.2	33.6	33.7	27.4	33.7
7'	20.1	25.9	20.1	20.2	22.5	20.2	19.9	19	19.9
6'	12.2	15.4	12.2	12.1	13.8	12.1	11.8	12.2	11.8
5'	7.6	9.3	7.6	7.4	8.5	7.4	7.2	7.7	7.2
4'	4.8	5.7	4.8	4.7	5.4	4.7	4.6	5	4.6
3'	3.2	3.7	3.2	3.1	3.5	3.1	3	3.3	3
2'	2.2	2.5	2.2	2.1	2.4	2.1	2.1	2.2	2.1
1'	1.5	1.7	1.5	1.5	1.6	1.5	1.5	1.6	1.5

HEIGHT ON WALL	2.5' FROM WALL								
	┌-2'-┐ on center		┌-2.5'-┐ on center		┌-3'-┐ on center				
10'	8.8	11.8	8.8	8.9	9.4	8.9	8.7	7.1	8.7
9'	30.6	38.6	30.6	32.9	30.7	32.9	33.6	23.4	33.6
8'	30.3	39.1	30.3	31.2	33.1	31.2	31.1	27.3	31.1
7'	22.8	28.9	22.8	22.8	25.5	22.8	22.3	22	22.3
6'	15.4	19.2	15.4	15.2	17.5	15.2	14.8	15.6	14.8
5'	10.2	12.4	10.2	10	11.5	10	9.7	10.5	9.7
4'	6.8	8.1	6.8	6.7	7.6	6.7	6.5	7.1	6.5
3'	4.6	5.4	4.6	4.5	5.1	4.5	4.4	4.8	4.4
2'	3.2	3.6	3.2	3.1	3.5	3.1	3.1	3.3	3.1
1'	2.3	2.5	2.3	2.2	2.5	2.2	2.2	2.4	2.2

HEIGHT ON WALL	3' FROM WALL								
	┌-2'-┐ on center		┌-2.5'-┐ on center		┌-3'-┐ on center				
10'	2.7	4	2.7	2.5	3.5	2.5	2.3	2.9	2.3
9'	18.3	24.5	18.3	18.7	20.6	18.7	18.6	16.6	18.6
8'	25	32.2	25	25.4	27.7	25.4	25.2	23.3	25.2
7'	22.4	28.1	22.4	22.2	25	22.2	21.7	22	21.7
6'	17	20.9	17	16.7	19.1	16.7	16.3	17.2	16.3
5'	12.1	14.6	12.1	11.9	13.6	11.9	11.6	12.5	11.6
4'	8.5	10	8.5	8.4	9.5	8.4	8.1	8.9	8.1
3'	6	6.9	6	5.9	6.6	5.9	5.7	6.3	5.7
2'	4.3	4.9	4.3	4.2	4.7	4.2	4.1	4.5	4.1
1'	3.1	3.5	3.1	3	3.4	3	3	3.2	3

ENTRA™ 3" LED

ADJUSTABLE DOWNLIGHT & WALL WASH

PHOTOMETRICS

Description: 3" LED Module
 20° Beam - 0° Tilt, 3000K
 Model: ENTRA Adjustable 20°
 Low Output
 Input Power (Watts): 11.9
 Input Power Factor: 0.98
 Absolute Luminous Flux (Lumens): 950
 Lumen Efficacy (Lumens per Watt): 80

Description: 3" LED Module
 40° Beam - 0° Tilt, 3000K
 Model: ENTRA Adjustable 40°
 Low Output
 Input Power (Watts): 11.9
 Input Power Factor: 0.98
 Absolute Luminous Flux (Lumens): 979
 Lumen Efficacy (Lumens per Watt): 82

Description: 3" LED Module
 65° Beam - 0° Tilt, 3000K
 Model: ENTRA Adjustable 65°
 Low Output
 Input Power (Watts): 11.9
 Input Power Factor: 0.98
 Absolute Luminous Flux (Lumens): 1022
 Lumen Efficacy (Lumens per Watt): 86

ANGLE	0°	45°	90°
0°	4213	4213	4213
5°	3746	3797	3620
10°	2524	2562	2359
15°	1429	1454	1292
20°	770	786	670
25°	435	439	358
30°	252	251	192
35°	132	136	99
40°	65	71	51
45°	30	38	24
50°	11	20	9
55°	5	9	4
60°	2	3	2
65°	1	1	1
70°	0	1	0
75°	0	0	0
80°	0	0	0
85°	0	0	0
90°	0	0	0

ANGLE	0°	45°	90°
0°	1822	1822	1822
5°	1771	1762	1770
10°	1624	1614	1588
15°	1413	1375	1289
20°	1130	1050	916
25°	795	700	562
30°	486	422	323
35°	267	242	175
40°	120	131	81
45°	49	65	33
50°	21	29	14
55°	10	10	7
60°	3	4	2
65°	0	2	0
70°	0	0	0
75°	0	0	0
80°	0	0	0
85°	0	0	0
90°	0	0	0

ANGLE	0°	45°	90°
0°	691	691	691
5°	701	691	680
10°	703	696	677
15°	708	707	686
20°	698	706	683
25°	658	667	647
30°	568	580	563
35°	436	449	436
40°	275	296	285
45°	145	161	150
50°	68	72	67
55°	28	30	28
60°	3	13	5
65°	0	3	0
70°	0	0	0
75°	0	0	0
80°	0	0	0
85°	0	0	0
90°	0	0	0

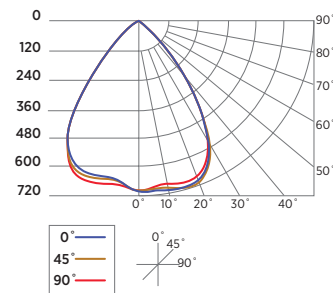
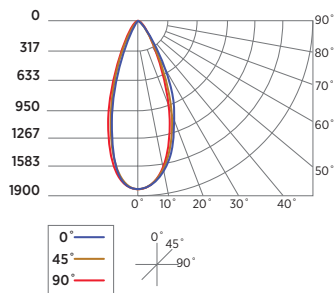
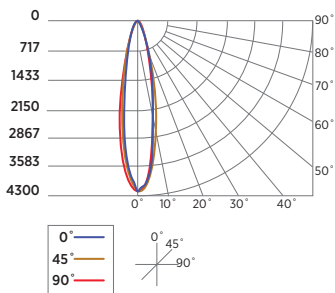
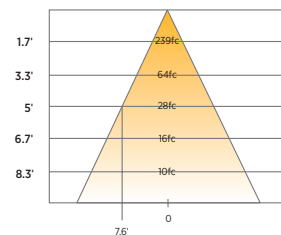
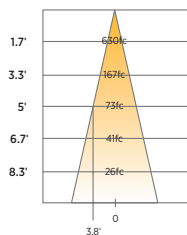
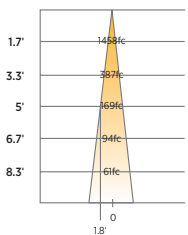

ENTRA™ 3" LED

ADJUSTABLE DOWNLIGHT & WALL WASH

PHOTOMETRICS

Description: 3" LED Module
20° Beam - 0° Tilt, 3000K

Model: ENTRA Adjustable 20°
High Output

Input Power (Watts): 18.3
Input Power Factor: 0.99

Absolute Luminous Flux (Lumens): 1311.9
Lumen Efficacy (Lumens per Watt): 71.4

Description: 3" LED Module
40° Beam - 0° Tilt, 3000K

Model: ENTRA Adjustable 40°
High Output

Input Power (Watts): 18.3
Input Power Factor: 0.99

Absolute Luminous Flux (Lumens): 1306.1
Lumen Efficacy (Lumens per Watt): 71.1

Description: 3" LED Module
65° Beam - 0° Tilt, 3000K

Model: ENTRA Adjustable 65°
High Output

Input Power (Watts): 18.3
Input Power Factor: 0.99

Absolute Luminous Flux (Lumens): 1255
Lumen Efficacy (Lumens per Watt): 68.4

ANGLE	0°	45°	90°
0°	4994	4994	4994
5°	4241	4230	4370
10°	2808	2800	2940
15°	1686	1670	1736
20°	981	677	982
25°	570	564	546
30°	315	314	291
35°	176	178	161
40°	99	102	93
45°	56	60	53
50°	30	36	28
55°	17	20	16
60°	8	10	8
65°	2	5	1
70°	1	1	1
75°	1	1	1
80°	0	0	0
85°	0	0	0
90°	0	0	0

ANGLE	0°	45°	90°
0°	2544	2544	2544
5°	2550	2468	2426
10°	2299	2200	2134
15°	1893	1795	1711
20°	1406	1312	1217
25°	908	840	763
30°	528	492	440
35°	294	283	248
40°	155	163	136
45°	83	93	72
50°	46	52	40
55°	25	28	22
60°	10	15	8
65°	1	6	1
70°	1	1	1
75°	0	0	1
80°	0	0	0
85°	0	0	0
90°	0	0	0

ANGLE	0°	45°	90°
0°	1091	1091	1091
5°	1076	1070	1086
10°	1036	1039	1058
15°	982	985	995
20°	910	907	899
25°	811	803	774
30°	682	674	624
35°	537	525	460
40°	373	366	302
45°	234	226	179
50°	134	126	100
55°	68	65	50
60°	14	34	8
65°	1	7	1
70°	0	1	1
75°	0	1	1
80°	0	0	0
85°	0	0	0
90°	0	0	0

