



DIRECTIONAL LIGHTS DL-22-SERIES



TYPE

SPECIFICATIONS

CONSTRUCTION: Cast aluminum, brass or 316 Stainless Steel Bullet; matching heavy duty cast aluminum, brass or 316 Stainless Steel adjustable swivel

LENS: High impact clear tempered convex glass

O-RING: High temperature red silicone

LAMP SUPPLIED: 20w MR16 FL(BAB) 5000 hours average rating (50w max)

LAMP OPTIONS: We recommend 20w MR16 ULTRA 10,000 hours average rating; 20 watt MR16 TITAN 18,000 hours average rating; 4w ARROW LED 50,000 average rating

SOCKET: High temperature ceramic GU5.3 bi-pin with 250°C silicone lead wires

WIRING: Black 3 foot 18/2 zip cord from base of fixture (12v only)

For 25 foot 16/2 fixture lead wire add -25F to catalog number.

CONNECTION: FA-05 Quick Connector (not supplied) from fixture to main cable (12/2, 10/2 or 8/2 only)

MOUNTING: FA-03 black 9" ABS stake threaded 1/2" NPS

FINISH: Aluminum-Black texture polyester powder coat. Optional finishes available. Brass-Unfinished brass. Optional finishes available. Stainless Steel - machined finish

ORDERING INFORMATION

CATALOG NO.	DESCRIPTION	LAMP	SHIP WEIGHT
DL-22-BLT	Cast aluminum Bullet	20w MR16 FL(BAB)	2.0 lbs.
DL-22-BRS	Cast brass Bullet	20w MR16 FL(BAB)	3.0 lbs.
DL-22-SS	Cast Stainless Steel Bullet	20w MR16 FL(BAB)	2.0 lbs.
DL-22-XEC-BLT	Cast aluminum Bullet, X-long collar	20w MR16 FL(BAB)	2.0 lbs.
DL-22-XEC-BRS	Cast brass Bullet, X-long collar	20w MR16 FL(BAB)	4.0 lbs.

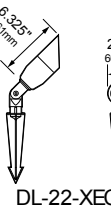
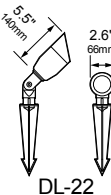

DL-22-BRS
mounted on
FA-24-BRS



MOUNTING ACCESSORIES

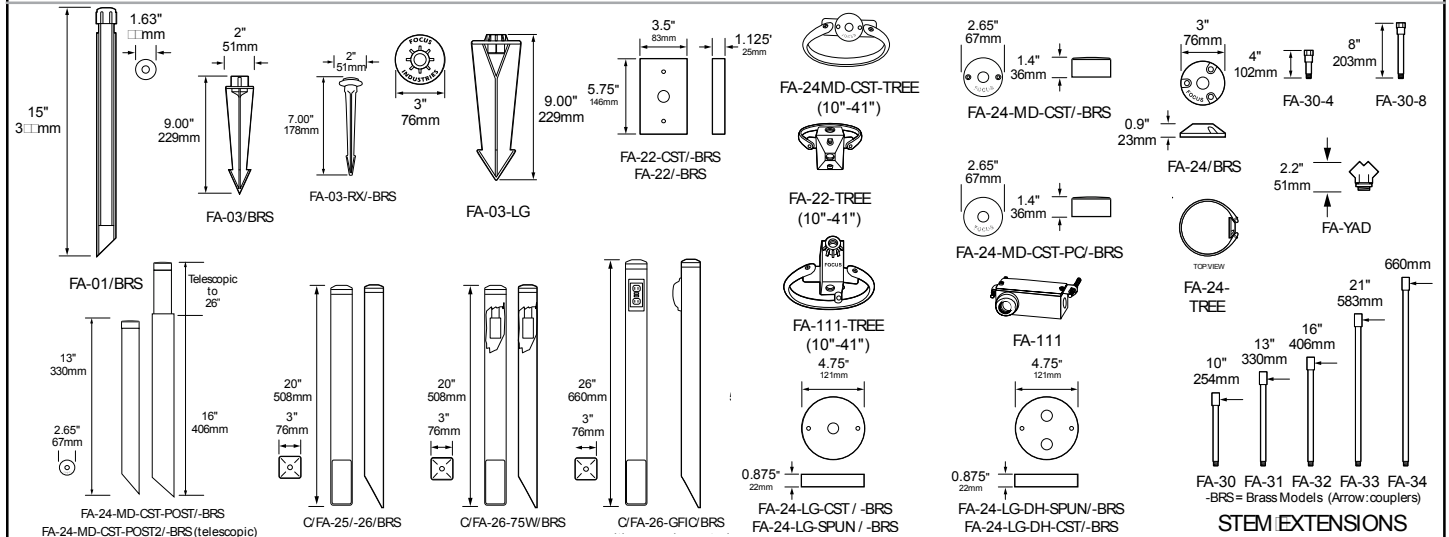

BEAM/GLARE CONTROL ACCESSORIES

FA-08-21	Round 1/8" Hex Cell Louver
FA-11-BLUE	Blue Tempered Glass Lens
FA-11-GREEN	Green Tempered Glass Lens
FA-98	Linear Spread Tempered Glass Lens
FA-99	High Impact Clear Tempered Convex Glass
FA-104	Wide Spread Tempered Glass Lens Softener

JOB INFORMATION

Type: _____ Date: _____

Job Name: _____

Cat. No.: _____

Lamp(s): _____

Specifier: _____

Contractor: _____

Notes: _____

FOCUS INDUSTRIES INC. www.focusindustries.com
25301 COMMERCENTRE DRIVE sales@ocusindustries.com
LAKE FOREST, CA 92630 (949) 830-1350 • FAX (949) 830-3390

Black Texture (Standard)	Antique Verde	Bronze Texture	Camel	White Texture	Hunter Texture	Rust	Weathered Iron	Weathered Brown	Stucco	Rubbed Verde	Chrome Powder	Terra Cotta	Acid Rust	Acid Verde	Black Acid Treatment
-BLT	-ATV	-BRT	-CAM	-WTX	-HTX	-RST	-WIR	-WBR	-STU	-RBV	-CPR	-TRC	-BAR/CAR	-BAV/CAV	-BAT



DIRECTIONAL LIGHTS DL-22-SERIES



TYPE

LIGHT DISTRIBUTIONS AND PHOTOMETRICS

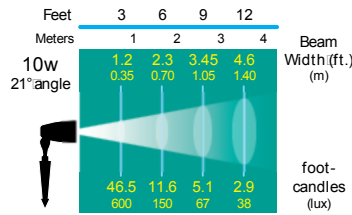

FL-13W-FG

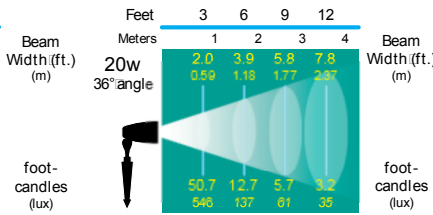

FL-13-BAB-FG

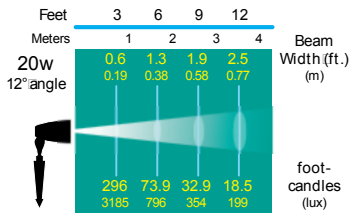

FL-13-ESX-FG

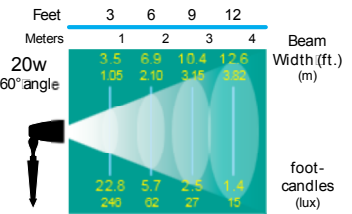

FL-13-VWFL-FG

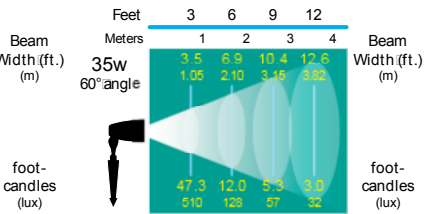

FL-15-FMW-60-FG

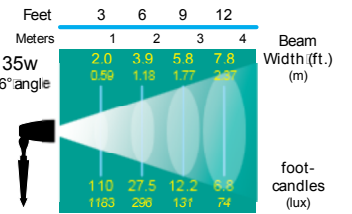

FL-15-FMW-ULTRA

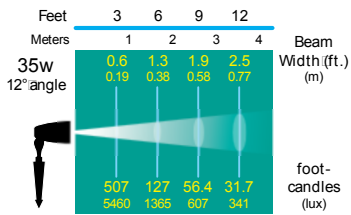

FL-15-FMT-FG

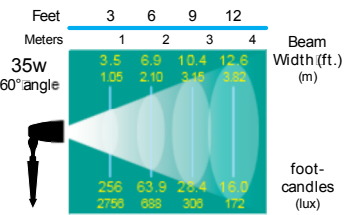

FL-15-FMV-FG
FL-15-FMV-ULTRA

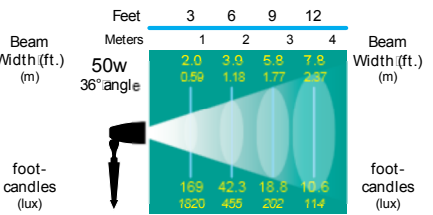

FL-10-EXN-FG
FL-10-EXN-ULTRA

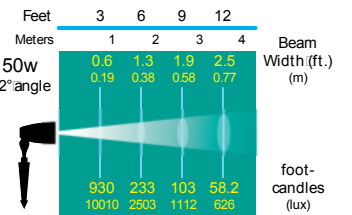

FL-10-EXT-FG
FL-10-EXT-ULTRA

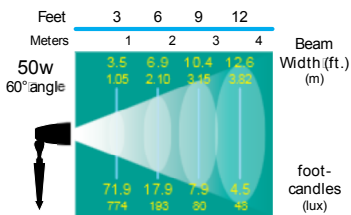

FL-10-VWFL-FG

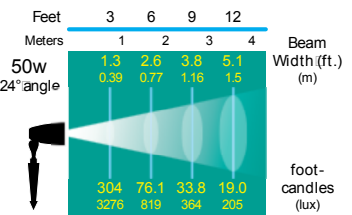

FL-10-EXZ-ULTRA

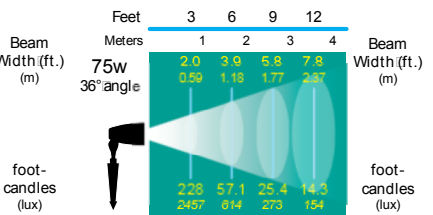

FL-13-EYC-FG

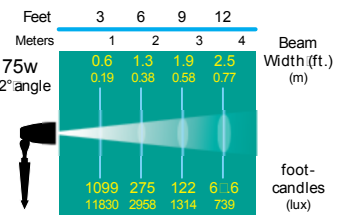

FL-20-%F-FG

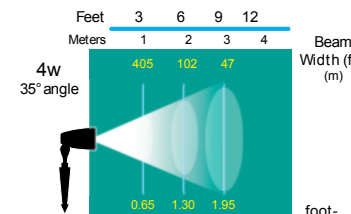

FL-LED-MR16-BAB

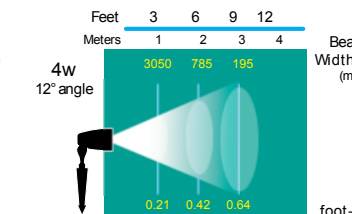

FL-LED-MR16-ESX

Black Texture (Standard)	Antique Verde	Bronze Texture	Camel	White Texture	Hunter Texture	Rust	Weathered Iron	Weathered Brown	Stucco	Rubbed Verde	Chrome Powder	Terra Cotta	Acid Rust	Acid Verde	Black Acid Treatment
-BLT	-ATV	-BRT	-CAM	-WTX	-HTX	-RST	-WIR	-WBR	-STU	-RBV	-CPR	-TRC	-BAR/CAR	-BAR/CAV	-BAT